

Errata

Title & Document Type: 5350A/51A/52A MW Frequency Counter
Operating & Programming Manual

Manual Part Number: 05350-90012

Revision Date: April 1, 1985

HP References in this Manual

This manual may contain references to HP or Hewlett-Packard. Please note that Hewlett-Packard's former test and measurement, semiconductor products and chemical analysis businesses are now part of Agilent Technologies. We have made no changes to this manual copy. The HP XXXX referred to in this document is now the Agilent XXXX. For example, model number HP8648A is now model number Agilent 8648A.

About this Manual

We've added this manual to the Agilent website in an effort to help you support your product. This manual provides the best information we could find. It may be incomplete or contain dated information, and the scan quality may not be ideal. If we find a better copy in the future, we will add it to the Agilent website.

Support for Your Product

Agilent no longer sells or supports this product. You will find any other available product information on the Agilent Test & Measurement website:

www.tm.agilent.com

Search for the model number of this product, and the resulting product page will guide you to any available information. Our service centers may be able to perform calibration if no repair parts are needed, but no other support from Agilent is available.



5350A 5351A 5352A

Microwave Frequency Counters

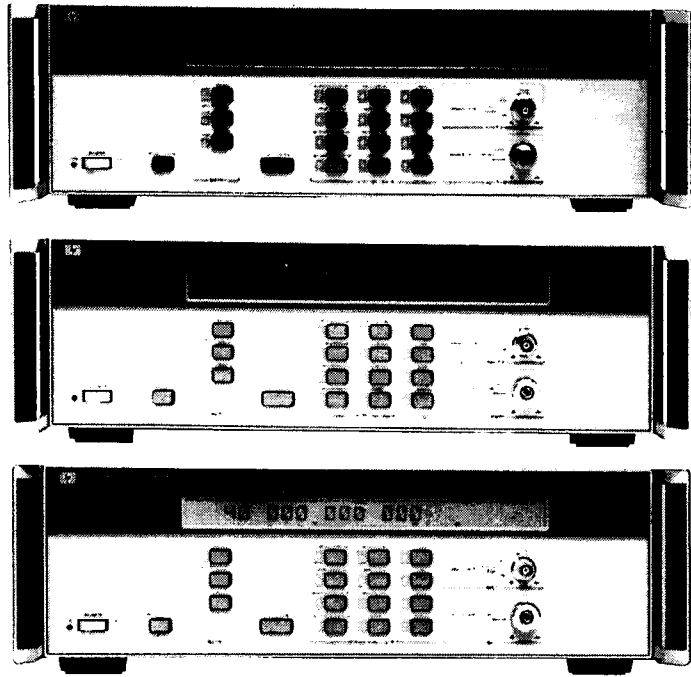

**HEWLETT
PACKARD**



CERTIFICATION

Hewlett-Packard Company certifies that this product met its published specifications at the time of shipment from the factory. Hewlett-Packard further certifies that its calibration measurements are traceable to the United States National Bureau of Standards, to the extent allowed by the Bureau's calibration facility, and to the calibration facilities of other International Standards Organization members.

WARRANTY

This Hewlett-Packard instrument product is warranted against defects in material and workmanship for a period of one year from date of shipment. During the warranty period, Hewlett-Packard Company will, at its option, either repair or replace products which prove to be defective.

For warranty service or repair, this product must be returned to a service facility designated by HP. Buyer shall prepay shipping charges to HP and HP shall pay shipping charges to return the product to Buyer. However, Buyer shall pay all shipping charges, duties, and taxes for products returned to HP from another country.

HP warrants that its software and firmware designated by HP for use with an instrument will execute its programming instructions when properly installed on that instrument. HP does not warrant that the operation of the instrument, or software, or firmware will be uninterrupted or error free.

LIMITATION OF WARRANTY

The foregoing warranty shall not apply to defects resulting from improper or inadequate maintenance by Buyer, Buyer-supplied software or interfacing, unauthorized modification or misuse, operation outside of the environmental specifications for the product, or improper site preparation or maintenance.

NO OTHER WARRANTY IS EXPRESSED OR IMPLIED. HP SPECIFICALLY DISCLAIMS THE IMPLIED WARRANTIES OF MERCHANTABILITY AND FITNESS FOR A PARTICULAR PURPOSE.

EXCLUSIVE REMEDIES

THE REMEDIES PROVIDED HEREIN ARE BUYER'S SOLE AND EXCLUSIVE REMEDIES. HP SHALL NOT BE LIABLE FOR ANY DIRECT, INDIRECT, SPECIAL, INCIDENTAL, OR CONSEQUENTIAL DAMAGES, WHETHER BASED ON CONTRACT, TORT, OR ANY OTHER LEGAL THEORY.

ASSISTANCE

Product maintenance agreements and other customer assistance agreements are available for Hewlett-Packard products.

For any assistance, contact your nearest Hewlett-Packard Sales and Service Office. Addresses are provided at the back of this manual.



*admaw
copy 2*

OPERATING AND PROGRAMMING MANUAL

HP 5350A, 5351A and 5352A Microwave Frequency Counters

OTS LIBRARY

SERIAL NUMBERS

This manual applies directly to instruments with serial numbers prefixed 2508A, unless accompanied by a Manual Change Sheet indicating otherwise.

For additional information about serial numbers, refer to INSTRUMENT AND MANUAL IDENTIFICATION in Section I.

IMPORTANT NOTICE

The operating and service information for this instrument is contained in two manuals, as follows:

HP 5350A/5351A/5352A Operating And Programming Manual
(HP P/N 05350-90012):

- I General Information
- II Installation
- III Operation And Programming
- IV Performance Tests

HP 5350A/5351A/5352A Service Manual (HP P/N 05350-90014):

- IV Performance Tests (duplicate)
- V Adjustments
- VI Replaceable Parts
- VII Manual Changes
- VIII Service

© Copyright HEWLETT-PACKARD COMPANY 1985
5301 STEVENS CREEK BOULEVARD, SANTA CLARA, CA 95050

MANUAL PART NUMBER 05350-90012
Microfiche Part Number 05350-90013

Printed: APRIL 1985

TABLE OF CONTENTS



Section	Title	Page
I	GENERAL INFORMATION	1-1
	1-1. Introduction	1-1
	1-3. Manual Summary	1-1
	 1-5. Specifications	1-1
	1-8. Safety Considerations	1-4
	1-10. Safety Symbols	1-4
	1-12. Instrument and Manual Identification	1-5
	1-17. Description	1-5
	1-21. Options	1-5
	1-24. Accessories	1-6
	1-27. Service Equipment Available	1-6
	1-29. Recommended Test Equipment	1-6
II	INSTALLATION	2-1
	2-1. Introduction	2-1
	2-3. Initial Inspection	2-1
	 2-5. Preparation for Use	2-1
	2-6. Power Requirements	2-1
	2-8. Line Voltage Selection	2-1
	2-14. Power Cable	2-2
	2-16. Operating Environment	2-4
	2-18. Hewlett-Packard Interface Bus	2-4
	2-19. HP-IB Interconnections	2-4
	2-21. Cable Length Restrictions	2-6
	2-23. HP-IB Talk/Listen Address	2-6
	2-25. HP-IB Descriptions	2-6
	2-27. Storage and Shipment	2-6
	2-28. Environment	2-6
	2-31. Packaging	2-6
	2-34. Field Installation of Options	2-7
	2-38. Installation of Option 001 or Option 010 Timebase	2-8
	2-40. Installation of Option 002 Rear Panel Input Connectors	2-8
	2-44. Installation of Option 006 Limiter	2-10
	2-48. Installation of Combined Options 002/006	2-12
III	OPERATION AND PROGRAMMING	3-1
	3-1. Introduction	3-1
	3-4. Operating Characteristics	3-1
	3-6. Overall Description	3-2
	3-11. Operating Ranges	3-2
	3-13. Resolution	3-2
	3-17. Automatic Mode	3-3
	3-19. Manual Mode	3-3
	3-21. Sample Rate	3-3
	3-23. FM Tolerance	3-3
	3-25. FM Rate Tolerance	3-4
	3-27. AM Tolerance	3-4
	3-29. Automatic Amplitude Discrimination	3-4
	3-31. Offset Frequencies	3-4
	3-33. Scale	3-4
	3-35. Smooth	3-4
	3-37. Self-Check	3-5

TABLE OF CONTENTS (Continued)

Section	Title	Page
3-39.	Diagnostics	3-5
3-41.	Remote Operation	3-5
3-43.	Characteristics With Options Installed	3-5
3-45.	Option 001 Oven Oscillator Timebase	3-5
3-47.	Option 002 Rear Panel Inputs	3-5
3-49.	Option 006 Limiter	3-6
3-51.	Option 010 High Stability Timebase	3-6
⚠ 3-53.	Maximum Input Signal Power	3-6
3-54.	High Frequency Input (INPUT 1)	3-6
3-56.	Low Frequency Input (INPUT 2)	3-6
3-58.	Input Cable Considerations	3-7
3-60.	Initial Power-Up Self Tests and Diagnostics	3-7
3-64.	Front Panel Features	3-7
3-66.	Keyboard	3-7
3-70.	Keyboard Memory	3-8
3-72.	Entering Parameter Values	3-9
3-76.	Key Functions	3-9
3-109.	Front Panel Display and Annunciators	3-15
3-112.	LCD Character Set	3-15
3-114.	Annunciator Descriptions	3-17
3-116.	Rear Panel Features	3-21
⚠ 3-118.	AC Power Input Module	3-21
3-120.	TCXO Adjustment	3-21
3-122.	HP-IB Connector	3-21
3-124.	HP-IB Address Switch	3-21
⚠ { 3-126.	External Reference In	3-21
3-128.	1 MHz Out, 10 MHz Out	3-21
3-130.	IF Out	3-22
3-132.	Rear Panel Input Connectors (Option 002)	3-22
3-134.	Operator's Maintenance	3-22
3-137.	Power-Up/Warm-Up	3-23
3-140.	Operator's Checks	3-23
3-142.	Power-Up Self Test	3-24
3-146.	Keyboard Check	3-25
3-151.	Power-Up Failures	3-25
3-155.	Error Messages	3-26
3-157.	Error Display Examples	3-26
3-159.	Overflow Warning	3-26
3-162.	Operating Procedures	3-27
3-163.	Introduction	3-27
3-174.	Preliminary Procedures	3-29
3-175.	Measurement Modes	3-30
3-176.	Power-Up Default Values	3-30
3-177.	Automatic Measurement Mode (AUTO)	3-30
3-178.	Manual Measurement Mode (MANUAL)	3-30
3-179.	Set Manual Center Frequency	3-31
3-180.	Set Manual Center Frequency to Last Measured Frequency ..	3-31
3-181.	Low Frequency, 50Ω Measurement Mode	3-32
3-182.	Low Frequency, 1MΩ Measurement Mode	3-32
3-183.	Measurement Modifiers	3-33
3-184.	Power-Up Default Values	3-33

TABLE OF CONTENTS (Continued)

Section	Title	Page
3-185.	Resolution	3-33
3-186.	Set Resolution	3-34
3-187.	High Resolution	3-35
3-188.	Sample Rate	3-36
3-189.	Set Sample Rate	3-37
3-190.	Trigger	3-38
3-191.	Set FM Rate Tolerance	3-38
3-192.	Math Functions	3-39
3-193.	Power-Up Default Values	3-39
3-194.	Offset	3-39
3-195.	Set Offset Frequency	3-40
3-196.	Set Offset Value to Last Frequency	3-41
3-197.	Scale	3-42
3-198.	Set Scale Value	3-43
3-199.	Smooth	3-43
3-200.	HP-IB	3-44
3-201.	Power-Up Default Values	3-44
3-202.	HP-IB Address	3-44
3-203.	Set HP-IB Address	3-45
3-204.	Diagnostic Functions	3-46
3-205.	Power-Up Default Values	3-46
3-208.	Self Check	3-46
3-209.	Diagnostics	3-46
3-210.	Set Diagnostic Number	3-47
3-211.	Move to Next Diagnostic	3-47
3-212.	Special Diagnostic Exit Procedures	3-48
3-214.	Auxiliary Functions	3-49
3-217.	Display IF	3-49
3-218.	Display MRC E & T Register Contents	3-49
3-219.	Display LO (Synthesizer) Frequency	3-49
3-220.	Display Harmonic Number (integer) and Sideband	3-50
3-221.	Display Harmonic Number (fraction) and Sideband	3-50
3-222.	Display Interpolator Short Calibration	3-50
3-223.	Display Interpolator Long Calibration	3-50
3-224.	Display Interpolator Measurement	3-50
3-225.	Remote Programming Via the HP-IB	3-51
3-226.	Introduction	3-51
3-229.	HP-IB Description	3-51
3-232.	Interface System Terms	3-52
3-234.	Major Interface Functions	3-52
3-238.	Interface Capabilities	3-53
3-241.	Front Panel Interface Status Annunciators	3-55
3-243.	Address Selection	3-56
3-248.	Interface Commands	3-58
3-251.	Device Independent Commands	3-58
3-254.	Meta Messages	3-59
3-259.	Remote Versus Local Measurements	3-62
3-261.	SRQ and Status Byte	3-62
3-267.	Status Byte Bit Descriptions	3-63
3-268.	Service Request Mask	3-64
3-273.	Device Dependent Commands	3-65

TABLE OF CONTENTS (Continued)

Section	Title	Page
3-275.	HP-IB Command Codes	3-65
3-278.	HP-IB Command Syntax Diagrams	3-65
3-281.	Command Syntax Overview	3-65
3-283.	Command Headers	3-66
3-287.	Data Separators	3-68
3-288.	Command Separators	3-68
3-289.	Data	3-68
3-291.	Numeric Data	3-68
3-296.	Character Data	3-70
3-298.	String Data	3-70
3-300.	Frequency Specifier	3-70
3-302.	Detailed Command Syntax Descriptions	3-70
3-305.	RESET: Instrument Reset	3-71
3-306.	CLR: Instrument Clear	3-71
3-307.	INIT: Instrument Initialization	3-71
3-308.	AUTO: Automatic Measurement Mode	3-72
3-309.	MANUAL: Manual Measurement Mode	3-72
3-310.	LOWZ: Input 2, 50 Ω Measurement Mode	3-72
3-311.	HIGHZ: Input 2, 1M Ω Measurement Mode	3-72
3-312.	TRIGGER and TRG: Trigger	3-72
3-313.	RESOL: Resolution	3-73
3-314.	SAMPLE: Sample Rate	3-73
3-315.	FMRATE: FM Rate Tolerance	3-73
3-316.	OFFSET: Offset	3-74
3-317.	SCALE: Scale	3-74
3-318.	SMOOTH: Smooth	3-74
3-319.	HIRESOL: High Resolution	3-74
3-320.	DIAG: Diagnostic	3-75
3-321.	DIAGPARAM: Diagnostic Parameter	3-75
3-322.	DISPLAY: Remote Display	3-76
3-323.	SRQMASK: Service Request Mask	3-77
3-324.	DUMP: Dump Mode	3-77
3-325.	SET: Instrument Setup	3-78
3-326.	SLEEP: Disable INPUT 1 Circuit	3-78
3-327.	HARMDET: Harmonic Number Determination	3-79
3-328.	TEST?: Send Self Check Results	3-79
3-329.	DIAG?: Send Diagnostic Results	3-79
3-330.	KEY?: Send Number of Last Key Pressed	3-80
3-331.	ID?: Send Identity	3-80
3-332.	SET?: Send Instrument Setup	3-80
3-333.	ERR?: Send Error Number	3-81
3-334.	REV?: Send Firmware Revision Datecode	3-81
3-335.	SER?: Send Serial Number	3-81
3-336.	REF?: Send Timebase Reference Status	3-81
3-337.	OVEN?: Send Oven Status	3-81
3-338.	HP-IB Data Output	3-82
3-339.	Frequency Measurements	3-82
3-344.	Diagnostic Results	3-82
3-346.	Other Outputs	3-82
3-348.	Numeric Output Format	3-83
3-354.	Query Output Formats	3-84
3-356.	Error Handling	3-84
3-361.	Programming Examples	3-84

TABLE OF CONTENTS (Continued)

Section	Title	Page
IV	PERFORMANCE TESTS	4-1
	4-1. Introduction	4-1
	4-3. Operation Verification	4-1
	4-5. Performance Test	4-1
	4-7. HP-IB Verification	4-1
	4-9. Equipment Required	4-1
	4-11. Calibration Cycle	4-1
	4-13. Test Record	4-2
	4-15. Option Test Specifications	4-2
	4-17. Operation Verification Procedure	4-3
	4-18. Power-Up Self Test	4-3
	4-19. INPUT 2, Gating and Counting Check	4-3
	4-20. INPUT 2, 10 Hz-525 MHz Input Sensitivity Test	4-4
	4-22. INPUT 1, 500 MHz-20 GHz 26.5 GHz, 40 GHz Input Sensitivity Test	4-6
	4-24. HP-IB Verification	4-8
	4-30. Performance Test Procedure	4-22
	4-31. INPUT 2, 10 Hz-525 MHz Input Sensitivity Test	4-22
	4-34. INPUT 1, 500 MHz-20 GHz 26.5 GHz, 40 GHz Input Sensitivity Test	4-24
	4-37. Automatic Amplitude Discrimination Test	4-27
	4-39. FM Tolerance Test	4-29
	4-41. HP-IB Verification Test	4-30

LIST OF TABLES

Table	Title	Page
1-1.	Model 5350A/5351A/5352A Specifications	1-2
1-2.	Safety Symbols	1-4
1-3.	Equipment Options Available	1-6
1-4.	Accessories Available	1-6
1-5.	Recommended Test Equipment	1-7
2-1.	AC Power Cables Available	2-3
2-2.	HP-IB Cable Descriptions	2-4
2-3.	Field Installable Options	2-8
3-1.	Key Assignments	3-8
3-2.	Parameter Values	3-9
3-3.	LCD Character Set	3-16
3-4.	Front Panel Annunciator Descriptions	3-17
3-5.	HP 5350A/51A/52A Error Messages	3-26
3-6.	High Resolution Displays	3-35
3-7.	HP 5350A/5351A/5352A HP-IB Interface Function Capabilities	3-53
3-8.	Address Selection	3-57
3-9.	Device Independent Commands	3-58
3-10.	Meta Messages	3-60
3-11.	Meta Messages and Controller Commands	3-62
3-12.	HP 5350A/5351A/5352A Status Byte	3-63
3-13.	HP 5350A/5351A/5352A Service Request Mask	3-64
3-14.	HP 5350A/51A/52A Programming Command Headers	3-67
3-15.	Character Data	3-70

LIST OF TABLES (Continued)

Table	Title	Page
4-1.	HP-85 Program Listing	4-10
4-2.	Sample HP-IB Verification Printout	4-20
4-3.	Operation Verification Record	4-21
4-4.	Performance Test Record	4-31

LIST OF FIGURES

Figure	Title	Page
1-1.	Model 5350A, 5351A and 5352A Microwave Frequency Counters and Power Cable	1-0
2-1.	Line Voltage Selection	2-2
2-2.	Hewlett-Packard Interface Bus Connection	2-5
3-1.	Liquid Crystal Display (LCD)	3-15
3-2.	Front Panel Features	3-19
3-3.	Rear Panel Features	3-20
3-4.	Details of INPUT 2 BNC Connector J2 and Fuse J2F1 Mounting	3-22
3-5.	Program Command Syntax	3-66
3-6.	Numeric Data Types	3-69

PREFACE

This manual contains the information required by the user to effectively operate and program the Hewlett-Packard Model 5350A, 5351A and 5352A Microwave Frequency Counters. The organization of this manual is designed to make quick reference of information easy, while still providing the overall depth of detail required by operating personnel.

The manual is divided into four sections, each relating to a specific topic. Each section is as self-contained as possible. Some sections provide learning and working information and will be used frequently. Other sections are dedicated to general and introductory types of information and are intended to be used only for reference. Where applicable, photos, illustrations, and diagrams are arranged to fold out from the manual to allow access to related information throughout the manual.

In limiting the depth of coverage in this manual, a certain amount of previous knowledge on the part of the reader is assumed. A variety of additional related documentation is available. The materials listed below provide in-depth coverage of specific areas of interest, and should be used to supplement this manual.

HP 5350A/5351A/5352A SERVICE MANUAL	05350-90014
AN 200 FUNDAMENTALS OF ELECTRONIC COUNTERS	5952-7506
AN 200-1 FUNDAMENTALS OF MICROWAVE FREQUENCY COUNTERS	5952-7484
LOGIC SYMBOLOGY	5951-6116
HP-IB TUTORIAL	59300-90007

SAFETY CONSIDERATIONS

GENERAL

The HP 5350A/5351A/5352A is a Safety Class I instrument provided with a protective earth terminal. The instrument is designed and tested to international safety standards.

This manual contains information, cautions, and warnings which must be followed by all persons operating or servicing the instrument to ensure safe operation and to retain the instrument in safe condition.

SAFETY SYMBOLS

Three of the most important safety symbols used on the instrument and in this manual are listed below. Refer to Section I for additional safety symbols before operating the instrument.



The **WARNING** sign denotes a hazard. It calls attention to a procedure or practice which could result in personal injury if not adhered to or correctly performed.



The **CAUTION** sign denotes a hazard. It calls attention to an operating procedure or practice which could result in damage to or destruction to part of or all of the product if not adhered to or correctly performed.



The **ATTENTION** symbol, when it appears on an instrument, means: Read the instruction manual before operating the instrument. The first three sections of the manual are particularly important. If the instrument is operated without reading the instructions, the instrument may not operate correctly.

WARNING

BEFORE CONNECTING POWER TO THE INSTRUMENT:

The protective earth terminals of this instrument must be connected to the protective conductor of the mains power cord. The mains plug must only be inserted in a socket outlet provided with a protective earth contact. This protection must not be negated by an extension power cord without a protective grounding (earthing) conductor. Grounding one conductor of a two conductor outlet is not sufficient protection.

Any interruption of the protective grounding conductor (inside or outside the instrument) or disconnecting the protective earth terminal will cause a potential shock hazard that could result in personal injury. Intentional interruption is prohibited.

If this instrument is to be energized via an autotransformer, make sure the common terminal is connected to the neutral terminal (earthed pole) of the power source. For continued protection against fire hazard, replace the line fuse only with a 250V fuse of the same current rating and specified type (normal blow, time delay, etc.). **DO NOT USE** repaired fuses or short-circuited fuseholders to replace blown fuses.

Whenever it is likely that the protection offered by grounding or fuses has been impaired, the instrument must be made inoperative and be secured against any unintended operation.

Service instructions, and adjustment procedures requiring removal of the instrument top or bottom covers, are for use by service-trained personnel only. To avoid dangerous electric shock, do not perform any servicing or make any adjustments with the covers removed, unless qualified to do so.

CAUTIONS

LINE VOLTAGE SELECTION

BEFORE CONNECTING POWER TO THE INSTRUMENT, make sure that the line voltage selector card (in the rear panel power module) is set to the correct voltage level for the ac voltage being applied, and that the correct fuse is installed. Refer to Section II, Installation.

MAXIMUM INPUT SIGNAL POWER

TO PREVENT DAMAGE TO THE INSTRUMENT, make sure that signals applied to the input do not exceed the input damage level specified for the instrument. Refer to Section I, Specifications.

ELECTROSTATIC DISCHARGE

Electronic components and assemblies can be permanently degraded or damaged by electrostatic discharge. Use the following precautions:

ENSURE that static sensitive devices or assemblies are serviced at static safe work stations providing proper grounding for service personnel.

ENSURE that static sensitive devices or assemblies are stored in static shielding containers.

DO NOT wear clothing subject to static charge buildup, such as wool or synthetic materials.

DO NOT handle components or assemblies in carpeted areas.

DO NOT remove a component or assembly from its static shielding protection until you are ready to install it.

AVOID touching component leads. (Handle by the plastic package only.)



5350A MICROWAVE FREQUENCY COUNTER



5351A MICROWAVE FREQUENCY COUNTER

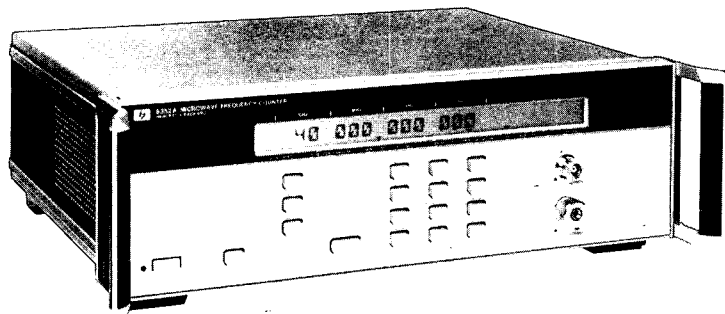

5352A MICROWAVE FREQUENCY COUNTER

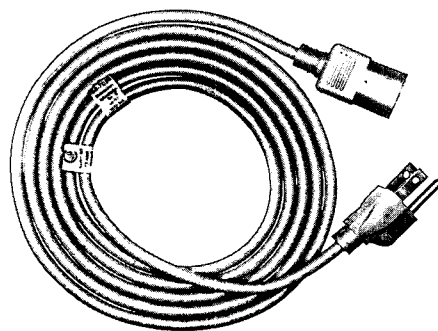

POWER CORD PART NO. 8120-1378

Figure 1-1. Model 5350A, 5351A and 5352A Microwave Frequency Counters and Power Cable

SECTION I GENERAL INFORMATION

1-1. INTRODUCTION

1-2. This Operating and Service Manual contains the information required to install, operate, and service the Hewlett-Packard Model 5350A, 5351A, and 5352A Microwave Frequency Counters.

1-3. MANUAL SUMMARY

1-4. This manual is divided into eight sections, each covering a particular topic for the operation and service of the HP Models 5350A, 5351A, and 5352A. The topics by section number are:

SECTION I, GENERAL INFORMATION: Briefly describes the instrument documented by this manual and covers instrument identification, specifications, safety considerations, options, accessories, recommended test equipment, and other basic information.

SECTION II, INSTALLATION: Provides information concerning initial inspection, preparation for use, storage and shipment, and HP-IB interconnections.

SECTION III, OPERATION AND PROGRAMMING: Provides information concerning operating characteristics, front and rear panel features, local and remote operating instructions, and operator's maintenance.

SECTION IV, PERFORMANCE TESTS: Provides abbreviated procedures for operational verification which give the operator a high degree of confidence that the counter is operating properly. Also provides performance test procedures which test the electrical performance of the instrument, using the specifications listed in Section I as performance standards.

SECTION V, ADJUSTMENTS: Provides the procedures required to properly maintain the instrument operating characteristics within specifications.

SECTION VI, REPLACEABLE PARTS: Provides ordering information for all replaceable parts and assemblies within the instrument.

SECTION VII, MANUAL CHANGES: This section is reserved for manual change information for adapting the manual to older instruments.

SECTION VIII, SERVICE: This section provides the instrument theory of operation, troubleshooting information, repair techniques, and schematic diagrams.



1-5. SPECIFICATIONS

1-6. The specifications for the HP 5350A, 5351A, and 5352A are listed in *Table 1-1*. These specifications are the performance standards or limits against which the instrument can be tested.

1-7. When discussing counter specifications in this manual, the information given will always apply to all three models unless otherwise indicated. Such indication will be shown by enclosing in brackets, [], any specification pertaining ONLY to an individual model. Any reference made in this manual to the "counter" or "instrument" will always pertain to all three models unless otherwise noted. When discussing the microwave frequency capabilities of the counters (>500 MHz), the term "MAX GHz" will be used to refer to the uppermost frequency limit of all three counters; a specific frequency range will be mentioned only when required to discuss characteristics of an individual model.

Table 1-1. Model 5350A/5351A/5352A Specifications

INPUT CHARACTERISTICS			
INPUT 1:	HP 5350A	HP 5351A	HP 5352A
Frequency Range:	500 MHz - 20.0 GHz	500 MHz - 26.5 GHz	500 MHz - 40 GHz
Sensitivity: Full Operating Environment 500 MHz to 12.4 GHz 12.4 GHz to 20.0 GHz 20.0 GHz to 26.5 GHz 26.5 GHz to 40 GHz @ 25°C (typical) 500 MHz to 12.4 GHz 12.4 GHz to 20.0 GHz 20.0 GHz to 26.5 GHz 26.5 GHz to 40 GHz	-25 dBm -20 dBm N/A N/A -30 dBm -25 dBm N/A N/A	-25 dBm -20 dBm -15 dBm N/A -30 dBm -25 dBm -20 dBm N/A	-25 dBm -25 dBm -25 dBm dBm = 0.741 f(GHz) -44.6 -30 dBm -30 dBm -30 dBm dBm = 0.741 f(GHz) -49.6
Maximum Input:	+7 dBm	+7 dBm	+7 dBm
Damage Level:	+25 dBm, peak	+25 dBm, peak	+25 dBm peak
Impedance:	50Ω nominal	50Ω nominal	50Ω nominal
Connector:	Precision Type N female	APC-3.5 male with collar, SMA compatible	
SWR: 500 MHz - 10 GHz 10 GHz - 20 GHz 20 GHz - 26.5 GHz 26.5 GHz - 40 GHz	<2:1 typical <3:1 typical N/A N/A	<2:1 typical <3:1 typical <3:1 typical N/A	<2:1 typical <3:1 typical <3:1 typical <3.5:1 typical
Coupling:	DC to 50Ω termination, AC to instrument		
Accuracy:	±1 count ±time base error × frequency		
Residual Stability:	When counter and source use common 10 MHz time base or counter uses external higher stability time base, 1 LSD (.3 LSD typical) rms for resolution 1 Hz - 1 kHz at 25°C; HP 5352A only 1.4 LSD (.7 LSD typical) 26.5 - 40 GHz; LSD = least significant digit.		
Resolution:	Selectable 1 Hz to 1 MHz		

INPUT 1: HP 5350A/5351A/5352A

FM Tolerance:

Maximum Deviation: 20 MHz p-p (12 MHz, 5352A)
Maximum FM Rate: 10 MHz

FM Rate Tolerance: Normal/Low (see figure A, next page)

Maximum Drift Rate:
Normal FM rate: 1 MHz/s
Low FM rate: 80 kHz/s

AM Tolerance: Any modulation index provided the minimum signal level is not less than the sensitivity specification.

Modes of Operation:

Automatic: Automatic amplitude discrimination is used to determine and display the frequency.
Manual: Center frequency must be entered to within ± 20 MHz of input frequency; ±3 MHz below 1 GHz; increases measurement and data output rate.

Automatic Amplitude Discrimination:

Automatically measures the largest of all signals present, providing that signal is >6 dB (typical) above any signal within 500 MHz; > 20 dB (typical) above any signal within 500 MHz to 20 (40) GHz.

Acquisition Time:

Automatic Mode:
Normal FM Rate: <200 ms
Low FM Rate: <1300 ms
Manual Mode:
< 40 ms after entering center Frequency

Gate Time: For 1 Hz resolution

500 MHz-5.7 GHz	200 ms
5.7-11.3 GHz	400 ms
11.3-16.9 GHz	600 ms
16.9-22.5 GHz	800 ms
>22.5 GHz	1000 ms

INPUT 2: HP 5350A/5351A/5352A

Frequency Range: 10 Hz to 525 MHz

Mode of Operation:

50Ω: 10 MHz to 525 MHz
1 MΩ: 10 Hz to 80 MHz

Sensitivity:

Full Operating Environment:
50Ω: 10 MHz to 525 MHz, 25 mV rms
1 MΩ: 10 Hz to 80 MHz, 25 mV rms
@ 25°C (typical):
50Ω: 10 MHz to 525 MHz, 15 mV rms
1 MΩ: 10 Hz to 80 MHz, 15 mV rms

Gate Time = 1/Resolution 1 ms minimum

Resolution: selectable 1 Hz to 1 MHz.

High Resolution: 1 MΩ mode: 0.001 Hz for <100 kHz input; 0.01 Hz for <1 MHz input; 0.1 Hz for <10 MHz input; 1 Hz for >10 MHz input: 1 second gate.

Accuracy: ± 1 count ±

$$\left(\frac{1.4 \times \text{Trigger Error} \oplus}{\text{Gate Time}} \pm \text{Time base} \right) \times \text{Frequency}$$

Impedance:

Selectable: 1 MΩ nominal shunted by <70 pF or 50Ω nominal

Coupling: AC

Connector: Replaceable fuse, Type BNC female

Maximum Input:

50Ω: + 10 dBm; 1 MΩ: 1V rms

Damage Level: 50Ω or 1 MΩ

DC - 5 kHz: 250V (DC + AC peak);
>5 kHz: 5.5V rms (+28 dBm) +
1.25 × 10⁶ V rms/FREQ

Panel Label: 5.5 V rms (+ 28 dBm)

Table 1-1. Model 5350A/5351A/5352A Specifications (Continued)

<p style="text-align: center;">TCXO TIME BASE</p> <p>Crystal Frequency: 10 MHz</p> <p>Stability: Aging Rate: $<1 \times 10^{-7}$ per month Short Term: $<1 \times 10^{-9}$ for 1 s averaging time Temperature: $<1 \times 10^{-6}$, 0-50°, if referenced to +25°C and set to the offset frequency Line Variation: $<1 \times 10^{-7}$ for 10% change from nominal</p> <p>Time Base Output: 10 MHz and 1 MHz, >2.4V square wave AC coupled into 1 kΩ: >1.5V p-p into 50Ω; available from rear panel BNC connectors whenever the instrument has AC power connected.</p> <p>External Time Base: 1, 2, 5 or 10 MHz, 0.7V min. to 8V max. p-p sine wave or square wave into >1 kΩ shunted by <30 pF, via rear panel BNC connector. External reference automatically selected when signal is present, an indicator (▼) appears in the display. TCXO power turned off, oven heater on, oscillator signal disconnected.</p> <p style="text-align: center;">OPTIONAL OVEN TIME BASE OPTION 001Ⓞ</p> <p>Crystal Frequency: 10 MHz</p> <p>Stability: Aging Rate: $<5 \times 10^{-10}$/day after 24-hour warm-up; $<1 \times 10^{-7}$/year for continuous operation. Short-Term: $<1 \times 10^{-10}$ for 1 s average Temperature: $<7 \times 10^{-9}$, 0-50°C Line Variation: $<1 \times 10^{-10}$ for 10% change from nominal. Warm-Up: $<5 \times 10^{-9}$ of final value 10 minutes after turn-on at 25°CⓄ</p> <p style="text-align: center;">OPTIONAL REAR PANEL INPUTS OPTION 002Ⓞ</p> <p>All specifications are the same except Input 1:</p> <p>SensitivityⓄ: 500 MHz to 12.4 GHz -24 dBm 12.4 GHz to 20.0 GHz -18 dBm 20.0 GHz to 26.5 GHz -12 dBm (5351A)</p> <p>SWR: 500 MHz -10 GHz (<2.5:1 typical) 10 GHz - 20 GHz (<3.5:1 typical) 20 GHz - 26.5 GHz (<3.5:1 typical, 5351A)</p>	<p style="text-align: center;">OPTIONAL INCREASED DAMAGE LEVEL OPTION 006Ⓞ</p> <p>Protects Input 1 from damage by limiting high level signals. All specifications are the same except Input 1:</p> <p>Damage Level 500 MHz to 6 GHz +39 dBm (8 Watts) 6 GHz to 18 GHz +36 dBm (4 Watts) 18 GHz to 26.5 GHz +34.8 dBm (3 Watts)</p> <p>SensitivityⓄ: 500 MHz to 12.4 GHz -22 dBm 12.4 GHz to 20.0 GHz -16 dBm 20.0 GHz to 26.5 GHz -10 dBm (5351A)</p> <p>SWR: 500 MHz - 10 GHz (<2.5:1 typical) 10 GHz - 20 GHz (<3.5:1 typical) 20 GHz - 26.5 GHz (<3.5:1 typical, 5351A)</p> <p style="text-align: center;">OPTIONAL HIGH STABILITY OVEN TIME BASE OPTION 010Ⓞ</p> <p>Crystal Frequency: 10 MHz</p> <p>Stability: Aging Rate: $<7 \times 10^{-10}$/week after 24 hrs; 1×10^{-10}/day (typical) after 30 days; $<2 \times 10^{-8}$/year for continuous operation. Short-Term: $<1 \times 10^{-10}$ for 1 s average Temperature: $<7 \times 10^{-9}$, 0-50°C Line Variation: $<1 \times 10^{-10}$ for 10% change from nominal. Warm-Up: $<5 \times 10^{-9}$ of final value 10 minutes after turn-on at 25°CⓄ</p> <p style="text-align: center;">GENERAL</p> <p>Display: Segmented 24 character alphanumeric LCD with 24 annunciators (backlighted); lockout (see Diagnostics)</p> <p>Keyboard: Set up stored in STBY mode; lockout (see Diagnostics).</p> <p>Self-Check: Tests for correct circuit operation using Lo frequency divided by ten.</p> <p>Diagnostics: Front panel or HP-IB selectable, Display and Keyboard Lockout, Service Diagnostics and User Information.</p>	<p>Data Output: Over HP-IB bus; varies with Frequency and Resolution</p> <p>Automatic Mode: ≈ 10 readings per second at 1 kHz Resolution.</p> <p>Manual Mode: >80 readings per second formatted at 10 kHz resolution, no math functions "DUMP MODE".</p> <p>Math Functions: Result = measurement \times scale + offset. Offset: Measurement is offset by entered value. Scale: Measurement is multiplied by entered value. Smooth: Displayed resolution is determined using exponential averaging; Displays only stable digits.</p> <p>Sample Rate: Variable from less than 50 ms between measurements to HOLD, which holds the display indefinitely or until Trigger occurs.</p> <p>Display Rate: 1:2/s, variable over HP-IB</p> <p>Overload Indication: "OVRLOAD" A user message; External pad or signal attenuation should be used to avoid damage.</p> <p>Sleep Mode: Input 1 emissions reduced to <-70 dBm typical when sleep mode or input 2 is selected.</p> <p>IF Output: Rear panel BNC provides 30-110 MHz down-converted microwave signal at >-20 dBm into 50Ω, AC coupled.</p> <p>HP-IB: Functions and diagnostics are programmable; address settable from front panel. Default switches on rear panel; Teach/Learn programming; IEEE 728 compatible command structure; Function subset SH1, AH1, T5, L4, SR1, RL1, PP0, DC1, DT1, C0, E1; Reset/local: returns to local control.</p> <p>Operating Temperature: 0°C to 50°C.</p> <p>Power Requirements: 100 VA max. Line Select: 100 V (90-105 VAC rms; 47.5-440 Hz) 115/120 (104-126 VAC rms; 47.5-440 Hz) 220 V (198-231 VAC rms; 47.5-66 Hz) 230/240 V (207-252 VAC rms; 47.5-66 Hz)</p> <p>Accessories Furnished: Power cord, manual Size: 5$\frac{1}{4}$" H \times 16" W \times 14" D/133 mmH \times 407 mmW \times 358 mmD Weight: 24 lbs./11 kg.</p>
--	---	---

① **Trigger Error:** $\frac{\sqrt{e_i^2 + e_n^2}}{\text{Input Slew Rate in V/s at Trigger point}}$ s rms

Where e_i = Effective rms noise of counter's input channel. (100 μ V typical)
 e_n = rms noise of the input signal for a 500 MHz bandwidth.

② For oscillator off time less than 24 hours. Final value is defined as frequency 24 hours after turn on; an indicator (▼) appears in the display until the oven reaches operating temperature.

③ Full operating environment: At 25°C sensitivity is typically 5 dB better.

④ Available with HP 5350A/5351A only

⑤ Options 001 and 010 are mutually exclusive.

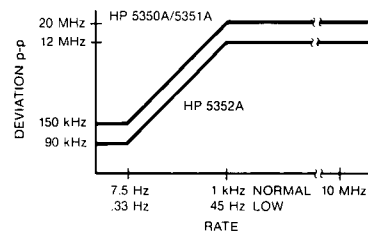

FM RATE TOLERANCE
FIGURE A









1-8. SAFETY CONSIDERATIONS

1-9. The HP 5350A/51A/52A is a Safety Class I instrument provided with a protective earth terminal. The instrument is designed and tested to international safety standards. Safety information pertinent to the operation and servicing of this instrument is included in appropriate sections of this manual.

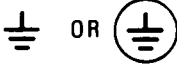
1-10. Safety Symbols

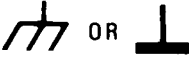
1-11. The safety symbols used on equipment and in manuals are shown in *Table 1-2*.

Table 1-2. Safety Symbols

	Instruction manual symbol. The product will be marked with this symbol when it is necessary for the user to refer to the instruction manual in order to prevent damage to the instrument.
	Indicates dangerous voltage at input or output terminals that may exceed 1000 volts.
	Protective conductor terminal. For protection against electrical shock in case of a fault. Used with field wiring terminals to indicate the terminal which must be connected to ground before operating the equipment.
	Low-noise or noiseless, clean ground (earth) terminal. Used for signal common as well as providing protection against electrical shock in case of fault. A terminal marked with this symbol must be connected to ground as described in Section II Installation in this manual before operating the equipment.
	Frame and chassis terminal. A connection to the frame (chassis) of the equipment which normally includes all exposed metal structures.
	Alternating current.
	Direct current.
	The WARNING signal denotes a hazard. It calls attention to a procedure or practice which could result in personal injury if not adhered to or correctly performed.
	The CAUTION signal denotes a hazard. It calls attention to an operating procedure or practice which could result in damage or destruction to part of or all of the product if not adhered to or correctly performed.

1-12. INSTRUMENT AND MANUAL IDENTIFICATION

1-13. The instrument serial number is located in the upper right corner of the rear panel. The serial number is in the form: 0000A00000. The first four digits and the letter are the serial number prefix. The last five digits are the suffix. The prefix is the same for all identical instruments; it changes only when a change is made to the instrument. The suffix, however, is assigned sequentially and is different for each instrument. The contents of this manual apply to instruments with the serial number prefix(es) listed under SERIAL NUMBERS on the title page.

1-14. An instrument manufactured after the printing of this manual may have a serial number prefix that is not listed on the title page. This unlisted serial number prefix indicates the instrument is different from those described in this manual. The manual for this newer instrument is accompanied by a yellow "Manual Changes" supplement. This supplement contains change information that explains how to adapt the manual to the newer instrument.

1-15. In addition to change information, the supplement may contain information for correcting errors in the manual. To keep this manual as current and accurate as possible, Hewlett-Packard recommends that you periodically request the latest Manual Changes supplement. The supplement for this manual is identified with the manual print date and part number, both of which appear on the manual title page. Complimentary copies of the supplement are available from Hewlett-Packard.

1-16. For information concerning a serial number prefix that is not listed on the title page or in the Manual Changes supplement, contact your nearest Hewlett-Packard office. Addresses and phone numbers of HP Sales and Support offices are located at the back of this manual.

1-17. DESCRIPTION

1-18. The HP 5350A is a CW microwave counter with a measurement range of 10 Hz to 20 GHz. The HP 5351A and 5352A counters are similar to the 5350A, with the 5351A having an extended measurement range of 10 Hz to 26.5 GHz, and the 5352A a range of 10 Hz to 40 GHz. All three counters combine high performance microwave measurements with simple, easy-to-use operating procedures. The HP 5350A/51A/52A is controlled by a single microprocessor which interacts with the counting circuitry to generate data, compute and display measurements, and manipulate measurement data.

1-19. All measurement modes and functions are selectable via 17 pushbutton keys on the front panel. Selectable functions include Sample Rate and Resolution control for the various measurement modes, and Math functions, such as Offset and Scale, for data manipulation. Additional power and convenience are provided by user-callable test and diagnostic functions which can be used for troubleshooting, and to obtain additional measurement information. The counter is equipped with memory for saving the front panel setup when the counter is set to Standby mode. All display functions are performed by a Liquid Crystal Display, which contains 24 alphanumeric characters (including function annunciators) for displaying both messages and measurement data.

1-20. Full HP-IB programmability is a standard feature of the HP 5350A/51A/52A Microwave Frequency Counter. The Hewlett-Packard Interface Bus provides remote control of measurement functions and data output. All front panel features are available via the HP-IB.

1-21. OPTIONS

1-22. There are four equipment options available for the HP 5350A/5351A [two for the 5352A], as listed in *Table 1-3*. Specifications for the options are listed in *Table 1-1*.

Table 1-3. Equipment Options Available

Option	Description	Instrument Model
001	Oven Oscillator Timebase	5350A/5351A/5352A
002	Rear Panel Input Connectors	5350A/5351A only
006	Limiter (Increased Damage Level)	5350A/5351A only
010	High Stability Timebase	5350A/5351A/5352A

1-23. If an option is included in the initial order, it will be installed at the factory and ready for operation upon receipt. All options may be ordered for field installation by ordering the parts listed in Section VI for a given option. Refer to Section II for installation instructions.

1-24. ACCESSORIES

1-25. The instrument is supplied with a detachable power cable, shown in *Figure 1-1*. The power cable supplied will have one of six possible line (mains) connectors, depending on the country of destination. Refer to *Table 2-1, AC Power Cables Available*, for the part number of the appropriate cable.

1-26. *Table 1-4* lists accessories available for the HP 5350A/51A/52A.

Table 1-4. Accessories Available

Description	HP Part Number
Extra Operating and Programming Manual } (Option 910) Extra Service Manual	05350-90012 05350-90014
Rack Mount Adapter Kits: With handles attached (Option 913) With handles removed (Option 908)	5061-2071 5061-0077

1-27. SERVICE EQUIPMENT AVAILABLE

1-28. Extender boards and cables are available to aid in servicing printed circuit board assemblies. The extender boards and cables allow assemblies to be extended from their plug-in connectors for monitoring with appropriate test equipment. Refer to *Table 1-5, Recommended Test Equipment*, for part numbers for ordering service equipment.

1-29. RECOMMENDED TEST EQUIPMENT

1-30. The test equipment listed in *Table 1-5* is recommended for use during performance tests, adjustments, and troubleshooting. Substitute test equipment may be used if it meets or exceeds the required characteristics listed in the table.

Table 1-5. Recommended Test Equipment

Instrument	Required Characteristics	Use*	Recommended Model
Oscilloscope	275 MHz bandwidth Delayed sweep capability	T,A	HP 1725A
Oscilloscope Probe (2 required)	High impedance (10:1) Minimal capacitance (8-10 pF)	T,A	HP 10017A
Active Probe	≥350 MHz 100:1 divide capability	T	HP 1120A
High Impedance Oscilloscope Probe	10MΩ or greater	T	HP 10014A
Storage Oscilloscope	100 MHz bandwidth Storage capability	T	HP 1744A
Sweep Oscillator	.01-20 GHz [26.5 GHz] Frequency Modulation capability 20 MHz p-p	OV,P	HP 8350B mainframe/ HP 83595A plug-in
Synthesized Signal Generator	10 MHz to 2.6 GHz 5% Amplitude Modulation 200 kHz FM p-p -40 dBm to +10 dBm	T,A	HP 8660C mainframe/ HP 86603A plug-in/ HP 86632B plug-in
Synthesizer	2 GHz to 26.5 GHz 1 Hz accuracy +4 dBm output	P	HP 8673B
Synthesizer	10 Hz to 10 MHz -20 dBm to +5 dBm	OV,P	HP 3325A
Spectrum Analyzer	RF inputs from 1 MHz to 500 MHz	T,P	HP 8565A
Digital Voltmeter	4 ½ digit AC/DC	T,A	HP 3466A
Variable Transformer	120V/240V	T	Allied Electronics P/N 927-6010(120V) P/N 927-6120(240V)
Signature Analyzer	TTL compatible QUAL mode required	T	HP 5005B
Power Meter	50 MHz to 20 GHz [50 MHz to 26.5 GHz]	A,OV,P	HP 436A
Power Sensor	50 MHz to 20 GHz [50 MHz to 26.5 GHz] -30 to +10 dBm	A,OV,P	HP 8485A
Frequency Counter	9-digit resolution	A	HP 5384A
Frequency Doubler	26.5-40 GHz Waveguide Output (UG599/U)	P	SpaceKom/Honeywell DKa-1

*T = Troubleshooting
A = Adjustments

OV = Operation Verification
P = Full Performance Testing

Table 1-5. Recommended Test Equipment (Continued)

Instrument	Required Characteristics	Use*	Recommended Model
Waveguide Attenuator	26.5-40 GHz	P	HP R382A
Amplifier	13.5-20 GHz +16 dBm output minimum 12 dB gain minimum	P	HP 8349A
Waveguide Directional Coupler	26.5-40 GHz 10 dB coupling	P	HP R752C
Power Meter	26.5-40 GHz	P	HP 432A
Power Sensor	26.5-40 GHz -15 to 0 dBm Waveguide connector	P	HP R486A
Waveguide-to-Coax Adapter	UG599/U to APC 3.5 female	P	Maury U230A
Waveguide-to-Coax Adapter	18-26.5 GHz UG599/U to APC 3.5 female	P	HP K281C Standard
Waveguide-to-Coax Adapter	18-26.5 GHz UG599/U to APC 3.5 male	P	HP K281C Option 012
Power Supply	480 mA @ 20V	T	HP 6216A
Sampling Voltmeter	±3% accuracy at 10 MHz	T	HP 3406A
Controller	IEEE-488 Interface compatible BASIC compatible	T,OV,P	HP-85B HP 82937A Interface HP 82936A ROM Drawer Advanced Programming ROM HP P/N 00085-15003
Power Splitter	DC to 26.5 GHz	OV,P	HP 11667B
50Ω Termination	DC to 26.5 GHz	P	HP 909D
50Ω Feedthrough Termination	BNC male to BNC female	OV,P	HP 10100C
Step Attenuator	DC to 26.5 GHz	OV,P	HP 8495D
Fixed Attenuator	20 dB Attenuation	A	HP 8491A Option 20
Extender Boards (2 required)	50 pin (2 X 25)	T	HP P/N 5060-0175
Extender Cable	SMB male to SMB female	T	HP P/N 05350-60102

*T = Troubleshooting
A = Adjustments

OV = Operation Verification
P = Full Performance Testing

Table 1-5. Recommended Test Equipment (Continued)

Instrument	Required Characteristics	Use*	Recommended Model
IF Test Cable	90° SMB female to BNC male	T	HP P/N 05350-60121
LO Test Cable	90° SMB male to BNC male	T	HP P/N 05350-60120
HP-IB Verification Tape	Rev. G or later	T,OV,P	HP P/N 59300-10002

*T = Troubleshooting
 A = Adjustments

OV = Operation Verification
 P = Full Performance Testing

SECTION II INSTALLATION

2-1. INTRODUCTION

2-2. This section contains information for unpacking, inspection, installation, and storage of the HP 5350A, 5351A and 5352A Microwave Frequency Counters.

2-3. INITIAL INSPECTION

2-4. If the shipping carton is damaged, inspect the instrument for visible damage (scratches, dents, etc.). If the instrument is damaged, notify the carrier and the nearest Hewlett-Packard Sales and Service Office immediately (offices are listed at the back of this manual). Keep the shipping carton and packing material for the carrier's inspection. The Hewlett-Packard Sales and Service Office will arrange for repair or replacement of your instrument without waiting for the claim against the carrier to be settled.

2-5. PREPARATION FOR USE

2-6. Power Requirements

2-7. The HP 5350A/51A/52A requires a power source of 100- or 115/120-volts ac (+5%, -10%) at 47.5 to 440 Hz single phase, or 220- or 230/240-volts ac (+5%, -10%,) at 47.5 to 66 Hz single phase; 100 VA maximum.



Before connecting the instrument to ac power lines, be sure that the correct fuse is installed and that the voltage selector is properly positioned as described below.

2-8. Line Voltage Selection

2-9. The instrument is equipped with an ac power module that contains a printed-circuit line voltage selector to select 100-, 120-, 220-, or 240-volt ac operation. Before applying power, the voltage selector must be set to the correct position and the correct fuse must be installed as described below.

2-10. Power line connections are selected by the position of the plug-in circuit card in the module. When the card is plugged into the module, the only visible marking on the card indicates the line voltage to be used. The correct value of line fuse, with a 250 volt rating, must be installed after the card is inserted. This instrument uses a 1.00 A time delay fuse (HP Part No. 2110-0007) for 100/120-volt operation, and a 0.5 A time delay fuse (HP Part No. 2110-0202) for 220/240-volt operation.

2-11. To convert from one line voltage to another, the power cord must first be disconnected from the power module. The sliding window covering the fuse and card compartment can then be moved to expose the fuse and circuit card. See *Figure 2-1*.

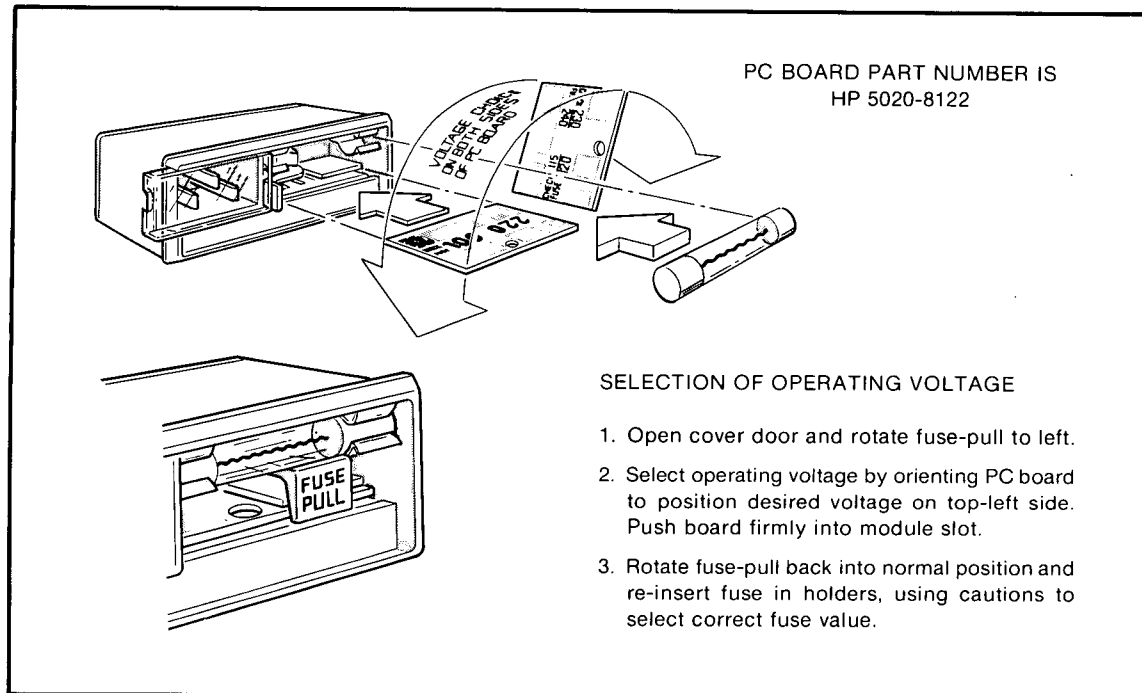

Figure 2-1. Line Voltage Selection

2-12. Pull on the fuse lever to remove the fuse and then pull the card out of the module. The fuse lever must be held to one side to extract and insert the card. Insert the card so the marking that agrees with the line voltage to be used is visible.

2-13. Return the fuse lever to normal position, insert the correct fuse, slide the plastic window over the compartment, and connect the power cord to complete the conversion.

2-14. Power Cable

2-15. The instrument is shipped with a three-wire power cable (W1). When the power cable is connected to an appropriate ac power source, it connects the chassis to earth ground. The type of power cable plug shipped with each instrument depends on the country of destination. Refer to Table 2-1 for the part numbers of the power cable and plug configurations available.

WARNING

BEFORE SWITCHING ON THIS INSTRUMENT, THE PROTECTIVE EARTH TERMINAL OF THIS INSTRUMENT MUST BE CONNECTED TO THE PROTECTIVE CONDUCTOR OF THE (MAINS) POWER CORD. THE MAINS PLUG SHALL ONLY BE INSERTED IN A SOCKET OUTLET PROVIDED WITH A PROTECTIVE EARTH CONTACT. THE PROTECTIVE ACTION MUST NOT BE NEGATED BY THE USE OF A POWER CORD EXTENSION CABLE WITHOUT A PROTECTIVE GROUNDING (EARTHING) CONDUCTOR.

Table 2-1. AC Power Cables Available

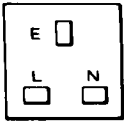
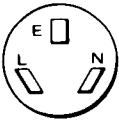
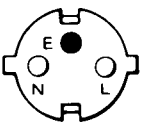
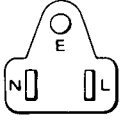
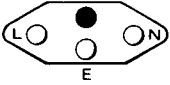
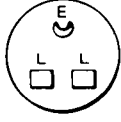
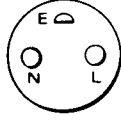
Plug Type	Cable HP Part No.	*C D	Plug Description	Cable Length (Inches)	Cable Color	For Use In Country
250V 	8120-1351 8120-1703	0 6	Straight **BS1363A 90°	90 90	Mint-Gray Mint Gray	United Kingdom, Cyprus, Nigeria Rhodesia, Singapore
250V 	8120-1369 8120-0696	0 4	Straight **NZSS198/ASC112 90°	79 87	Gray Gray	Australia, New Zealand
250V 	8120-1689 8120-1692	7 2	Straight **CEE7-Y11 90°	79 79	Mint Gray Mint Gray	East and West Europe, Saudi Arabia, Egypt, So Africa, India (Unpolarized in many nations)
125V 	8120-1348 8120-1398 8120-1754 8120-1378 8120-1521 8120-1676	5 5 7 1 6 2	Straight **NEMA5-15P 90° Straight **NEMA5-15P Straight **NEMA5-15P 90° Straight **NEMA5-15P	80 80 36 80 80 30	Black Black Black Jade Gray Jade Gray Jade Gray	United States, Canada, Japan (100V or 200V), Mexico, Philippines, Taiwan
250V 	8120-2104	3	Straight **SEV1011 1959-24507 Type 12	79	Gray	Switzerland
250V 	8120-0698	6	Straight **NEMA6-15P			United States, Canada
220V 	8120-2956 8120-2957	2 3	Straight **DHCK 107 90°	79 79	Gray Gray	Denmark

*CD = Check Digit (refer to Section VI).

**Part number shown for plug is industry identifier for plug only. Number shown for cable is HP Part Number for complete cable including plug.

E = Earth Ground L = Line N = Neutral



2-16. Operating Environment

2-17. The instrument may be operated within the following environmental limits:

- a. TEMPERATURE. The HP 5350A, 5351A and 5352A may be operated in temperatures from 0°C to +50°C.
- b. HUMIDITY. The HP 5350A, 5351A and 5352A may typically be operated in environments with humidity up to 95% at 40°C. However, it should be protected from temperature extremes which cause condensation within the instrument.
- c. ALTITUDE. The HP 5350A, 5351A and 5352A may be typically operated at altitudes up to 4,600 metres (15,000 feet).

2-18. HEWLETT-PACKARD INTERFACE BUS



The above symbol when located in the upper corner of a page indicates HP-IB information is contained on that page. This information may be operation, performance, adjustment, or service related.

2-19. HP-IB Interconnections

2-20. The HP 5350A/51A/52A is compatible with the Hewlett-Packard Interface Bus. Interconnection data concerning the rear panel HP-IB connector is provided in *Figure 2-2*. This connector is compatible with the HP 10833A/B/C/D cables. (Refer to *Table 2-2* for cable descriptions.) The HP-IB system allows interconnection of up to 15 (including the controller) HP-IB compatible instruments. The HP-IB cables have identical “piggy-back” connectors on both ends so that several cables can be connected to a single source without special adapters or switch boxes. System components and devices may be connected in virtually any configuration desired. There must, of course, be a path from the controller to every device operating on the bus. As a practical matter, avoid stacking more than three or four cables on any one connector. If the stack gets too large, the force on the stack produces leverage which can damage the connector mounting. Be sure each connector is firmly (finger tight) screwed in place to keep it from working loose during use. DO NOT use a screwdriver to tighten the connector lockscrew, as doing so may damage the threads inside the head of the lockscrew.

Table 2-2. HP-IB Cable Descriptions

Model Number	Cable Length
10833A	1 metre (3.3 ft.)
10833B	2 metres (6.6 ft.)
10833C	4 metres (13.2 ft.)
10833D	0.5 metres (1.6 ft.)



PIN	LINE
1	DIO1
2	DIO2
3	DIO3
4	DIO4
13	DIO5
14	DIO6
15	DIO7
16	DIO8
5	EOI
17	REN
6	DAV
7	NRFD
8	NDAC
9	IFC
10	SRQ
11	ATN
12	SHIELD-CHASSIS GROUND
18	P/O TWISTED PAIR WITH PIN 6
19	P/O TWISTED PAIR WITH PIN 7
20	P/O TWISTED PAIR WITH PIN 8
21	P/O TWISTED PAIR WITH PIN 9
22	P/O TWISTED PAIR WITH PIN 10
23	P/O TWISTED PAIR WITH PIN 11
24	ISOLATED DIGITAL GROUND

THESE PINS
ARE
INTERNALLY
GROUNDED

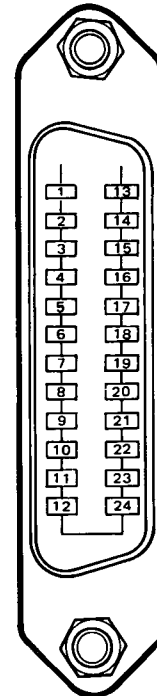

CAUTION

The 5350A/51A/52A contains metric threaded HP-IB cable mounting studs as opposed to English threads. Metric threaded HP 10833A, B, C, or D HP-IB cable lock screws must be used to secure the cable to the instrument. Identification of the two types of mounting studs and lock screws is made by their color. English threaded fasteners are colored silver and metric threaded fasteners are colored black. DO NOT mate silver and black fasteners to each other or the threads of either of both will be destroyed.

HP-IB MOUNTING
STUD
0380-1332

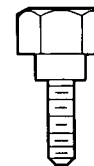

Logic Levels

The Hewlett-Packard Interface Bus logic levels are TTL compatible, i.e., the true (1) state is 0.0V dc to +0.8V dc and the false (0) state is +2.0V dc to +5.0V dc.

Programming and Output Data Format

Refer to Section III, Operation

Mating Connector

HP 1251-7162; Amphenol 57-92245.

Mating Cables Available

HP 10833A, 1 metre (3.3 ft.), HP 10833B, 2 metres (6.6 ft.)
HP 10833C, 4 metres (13.2 ft.), HP 10833D, 1/2 metre (1.6 ft.)

Cabling Restrictions

1. A Hewlett-Packard Interface Bus System may contain no more than 2 metres (6.6 ft.) of connecting cable per instrument.
2. The maximum accumulative length of connecting cable for any Hewlett-Packard Interface Bus System is 20.0 metres (65.6 ft.).
3. The maximum number of instruments in one system is fifteen.

Figure 2-2. Hewlett-Packard Interface Bus Connection



2-21. Cable Length Restrictions

2-22. To achieve design performance with the HP-IB, the proper voltage levels and timing relationships must be maintained. If the system cable is too long, the system will fail to perform properly. Therefore, when interconnecting an HP-IB system, it is important to observe the following rules:

- a. The total cable length for the system must be less than or equal to 20 metres (65 feet).
- b. The total cable length for the system must be less than or equal to 2 metres (6.6 feet) times the total number of devices connected to the bus.
- c. The total number of instruments connected to the bus must not exceed 15.

2-23. HP-IB Talk/Listen Address

2-24. There are two ways to set the HP-IB instrument address for remote operation: setting the rear panel address switch, and front panel keyboard entry. The rear panel switch setting determines the mode of remote operation as "Talk Only" or "Addressable", and selects the HP-IB address. The HP-IB address can also be set by entering the address as numeric data via the front panel keyboard, in which case the address set via the rear panel switch is overridden. The HP-IB address entered via the keyboard will be retained by the counter as long as ac power is connected to the instrument. Instructions for setting and changing the address are provided in Section III of this manual.

2-25. HP-IB Descriptions

2-26. A description of the HP-IB is provided in Section III of this manual. A study of this information is necessary if the user is not familiar with the HP-IB concept. Additional information concerning the design criteria and operation of the bus is available in IEEE Standard 488-1978, titled "IEEE Standard Digital Interface for Programmable Instrumentation." Refer to Section III for a list of Hewlett-Packard manuals that provide additional background information on using HP-IB.

2-27. STORAGE AND SHIPMENT

2-28. Environment

2-29. The instrument may be stored or shipped in environments within the following limits:

TEMPERATURE	- 40°C to +75°C
HUMIDITY	Up to 95% noncondensing
ALTITUDE	15,240 metres (50,000 feet)

2-30. The instrument should be protected from temperature and humidity extremes which cause condensation within the instrument.

2-31. Packaging

2-32. **ORIGINAL PACKAGING.** Containers and materials identical to those used in the factory packaging are available through Hewlett-Packard offices. If the instrument is being returned to Hewlett-Packard for servicing, attach a tag indicating the type of service required, return address, model number, and full serial number. Also, mark the container FRAGILE to ensure careful handling. In any correspondence, refer to the instrument by model number and full serial number.

2-33. **OTHER PACKAGING.** The following general instructions should be used for repacking with commercially available materials.

- a. Wrap the instrument in heavy paper or plastic. If shipping to a Hewlett-Packard office or service center, attach a tag indicating the type of service required, return address, model number, and full serial number.
- b. Use a strong shipping container. A double-wall carton made of 350-pound test material is adequate.
- c. Use a layer of shock-absorbing material 70 to 100 mm (3 to 4 inches) thick around all sides of the instrument to provide firm cushioning and prevent movement inside container. Protect control panel with cardboard.
- d. Seal the shipping container securely.
- e. Mark the shipping container FRAGILE to ensure careful handling.
- f. In any correspondence, refer to the instrument by model number and full serial number.

2-34. FIELD INSTALLATION OF OPTIONS

2-35. Procedures for field installation of all options for the HP 5350A/51A/52A are described in the following paragraphs. To obtain the necessary parts for installation of an option, order the parts listed for the desired option in *Table 2-3*. Unless otherwise noted, the parts listed in the table are required for installing the option in any of the three models. (Note that Options 002 and 006 are available only for the 5350A and 5351A.) Refer to Section VI for ordering information.

2-36. After field installation of an option, the rear panel "OPTIONS" label should be updated to identify the option which has been installed. To update the label, fill in the small circle next to the appropriate option name with a marking pen.

WARNING

TO PREVENT ELECTRIC SHOCK, BE SURE TO DISCONNECT AC POWER TO THE INSTRUMENT BEFORE INSTALLING ANY OPTIONS. CAPACITORS INSIDE THE INSTRUMENT MAY STILL BE CHARGED AFTER AC POWER IS REMOVED. THEREFORE, ALL OPTION INSTALLATION SHOULD BE PERFORMED BY QUALIFIED SERVICE PERSONNEL WHO ARE AWARE OF THE HAZARDS INVOLVED.

CAUTION

Integrated circuit assemblies in the instrument can be damaged by electrostatic discharge. Use the following precautions:

ENSURE that all option installations are performed at a static safe work station.

DO NOT wear clothing subject to static charge, such as wool or synthetic material.

Table 2-3. Field Installable Options

Option	Part Description	Ref. Desig.	Part Number
001	Oven Oscillator Timebase 2 Mounting Screws	A10 A10H1	10811-60111 2360-0115
002 (5350A/5351A only)	5350A Rear Panel Input Cable	W9	05350-60110
	or 5351A Rear Panel Input Cable	W12	05351-60102
006 (5350A/5351A only)	Limiter Option Cable (5350A only) Limiter (5350A/5351A)	W10 AT1	05350-60111 5088-7049
010	High Stability Timebase 2 Mounting Screws	A10 A10H1	10811-60211 2360-0115

2-37. The installation procedures in the following paragraphs include only those details required for installation of the specified options. Procedures for general disassembly and reassembly of the instrument (for example, removal of top and bottom covers or removal of the front panel assembly, etc.) are given in Section VIII.

2-38. Installation of Option 001 or Option 010 Timebase

2-39. The Option 001 Oven Oscillator Timebase and the Option 010 High Stability Oscillator Timebase are installed in exactly the same way. Each option consists of an oven-controlled crystal oscillator time base (HP Part No. 10811-60111 for Option 001, 10811-60211 for Option 010). (See Figure 6-5.) Either option is installed in the XA10 connector on the motherboard, replacing the standard A10 oscillator. To install Option 001 or 010, proceed as follows:

- a. Disconnect ac power from the instrument.
- b. Remove top and bottom covers of the instrument.
- c. Remove the standard oscillator from connector XA10.
- d. Install the Option 001 or 010 oscillator into the XA10 connector, and secure the oscillator to the motherboard from underneath with the two mounting screws provided with the option kit (A10H1).
- e. Replace bottom cover of the instrument.
- f. Perform the Option 001/010 oscillator adjustment as described in Section V, Adjustments.
- g. Replace top cover of the instrument.

2-40. Installation of Option 002 Rear Panel Input Connectors

2-41. Option 002 consists of special semi-rigid cable assemblies (W9 for the 5350A, W12 for the 5351A) for installing the INPUT 1 and INPUT 2 connectors in the rear panel. (See Figure 6-6). Option 002 is available only for the 5350A and 5351A.

2-42. To install Option 002 for the 5350A, proceed as follows:

- a. Disconnect ac power from the instrument.
- b. Remove the top cover of the instrument.

- c. Remove the front panel assembly, and the attached Microwave Module, from the front frame of the instrument. (Refer to the disassembly procedures in Section VIII.)
 - d. Unscrew the knurled nut (H12) from the INPUT 1 type-N connector on the High Frequency Input Cable (W6), and separate the Microwave Module from the front panel assembly.
 - e. Disconnect the W6 input cable from the Microwave Module, using a 5/16 inch wrench to loosen the SMA connector.
 - f. Remove the metal plugs (MP3, MP4) covering the two rear panel input holes, and insert the type-N connector of the W6 input cable into the larger of the two holes. Loosely screw the knurled nut onto the connector from the outside of the rear panel. **DO NOT TIGHTEN** the nut at this time.
 - g. Remove the 9/16 inch hex nut (H27) and lockwasher (H16) which secure the INPUT 2 BNC connector to the front panel. Remove the INPUT 2 connector from the front panel and install it in the appropriate hole in the rear panel, securing it with the H27 hex nut and H16 lockwasher. Reconnect the A2W1 coaxial cable (disconnected during removal of the front panel assembly) to the INPUT 2 connector. The A2W1 cable should be routed through the cutout in the card cage strut next to the T1 transformer.
 - h. Take the 5350A Rear Panel Input Cable (W9) and insert it through the cutout in the card cage strut. The hook-shaped end of the cable should be nearer to the front panel.
 - i. Connect the W9 cable to the W6 input cable, finger-tightening the SMA connection only a turn or two. **DO NOT TIGHTEN** the connection all the way.
 - j. Place the Microwave Module in its normal location in the instrument, and connect the W9 cable to the Microwave Module SMA connector (U1J1). **DO NOT TIGHTEN** the connection all the way.
 - k. Reinstall the front panel assembly, being careful to keep the semi-rigid cables properly aligned. (Refer to reassembly procedures in Section VIII.) Insert the metal plugs which were removed from the rear panel input holes into the front panel input holes.
 - l. Tighten both SMA cable connections, using a 5/16 inch wrench. The Microwave Module connector should be tightened before tightening the W9 cable connection to W6. **DO NOT OVERTIGHTEN** the SMA connectors. Finally, tighten the knurled nut on the rear panel INPUT 1 connector, using a 3/4 inch knurled nut driver.
 - m. Replace the top cover.
 - n. Perform the tests described in Section IV, Performance Tests to verify that the instrument meets the Option 002 specifications in *Table 1-1*.
- 2-43. To install Option 002 for the 5351A, proceed as follows:
- a. Disconnect ac power from the instrument.
 - b. Remove the top cover.
 - c. Remove the front panel assembly, with the attached Microwave Module, from the front frame of the instrument. (Refer to the disassembly procedures in Section VIII.)

- d. Using a 0.062 inch Allen wrench, loosen 3 set-screws securing the connector collar (MP37) to the INPUT 1 APC-3.5 connector. Remove the collar and the knurled nut (H12) from the INPUT 1 connector. Separate the Microwave Module from the front panel assembly.
- e. Disconnect the W11 semi-rigid input cable from the Microwave Module, using a 5/16 inch wrench. Once disconnected from the Microwave Module, the W11 cable and the INPUT 1 connector (consisting of connector assembly J1, and threaded spacer MP38) can be removed from the Microwave Module mounting bracket.
- f. Disconnect the W11 cable from the INPUT 1 connector and set the cable aside, as it is not used as part of the Option 002 installation.
- g. Remove the metal plugs (MP3, MP4) covering the two rear panel input holes, and insert the INPUT 1 connector into the larger of the two holes. Loosely screw the knurled nut onto the connector. DO NOT TIGHTEN the connector all the way.
- h. Remove the 9/16 inch hex nut (H27) and lockwasher (H16) which secure the INPUT 2 BNC connector to the front panel. Remove the INPUT 2 connector from the front panel and install it in the appropriate hole in the rear panel, securing it with the H27 hex nut and H16 lockwasher. Reconnect the A2W1 coaxial cable (disconnected during removal of the front panel assembly) to the INPUT 2 connector. The A2W1 cable should be routed through the cutout in the card cage strut next to the T1 transformer.
- i. Take the 5351A Rear Panel Input Cable (W12) and insert it through the cutout in the card cage strut. The hook-shaped end of the cable should be placed nearer to the front panel. Connect the cable to the INPUT 1 connector, finger-tightening the SMA connection only a turn or two. DO NOT TIGHTEN the connection all the way.
- j. Place the Microwave Module in its normal location in the instrument, and connect the W12 cable to the Microwave Module connector (U1J1). DO NOT TIGHTEN the SMA connection all the way.
- k. Reinstall the front panel assembly, being careful to keep the semi-rigid cable properly aligned. (Refer to reassembly procedures in Section VIII.) Insert the metal plugs which were removed from the rear panel input holes into the front panel input holes.
- l. Tighten all SMA cable connections, using a 5/16 inch wrench. The Microwave Module connector should be tightened before tightening the W12 cable connection to the INPUT 1 connector. DO NOT OVERTIGHTEN the SMA connections.
- m. Tighten the H12 knurled nut on the rear panel INPUT 1 connector, using a 3/4 inch knurled nut driver. Place the MP37 connector collar onto the connector, and tighten the 3 set-screws.
- n. Replace the top cover.
- o. Perform the tests described in Section IV, Performance Tests to verify that the instrument meets the Option 002 specifications in *Table 1-1*.

2-44. Installation of Option 006 Limiter

2-45. Option 006 consists of a Microwave Limiter (HP P/N 5088-7049) inserted in series between the INPUT 1 connector on the front panel and the Microwave Module input (U1J1). (See *Figure 6-4*.) Option 006 is available only for the 5350A and 5351A.

2-46. To install Option 006 for the 5350A, proceed as follows:

- a. Disconnect ac power from the instrument.
- b. Remove the top cover.
- c. Remove the front panel assembly, with the attached Microwave Module, from the front frame of the instrument. (Refer to the disassembly procedures in Section VIII.)
- d. Unscrew the knurled nut (H12) from the INPUT 1 type-N connector on the High Frequency Input Cable (W6), and separate the Microwave Module from the front panel assembly.
- e. Disconnect the W6 input cable from the Microwave Module, using a 5/16 inch wrench. Set the W6 cable aside, as it is not used for the Option 006 installation.
- f. Insert the type-N connector on the Option 006 Input Cable (W10) into the rectangular hole in the mounting bracket of the Microwave Module.
- g. Connect the Microwave Limiter (AT1) to the SMA connector of the W10 cable. **DO NOT TIGHTEN** the connection all the way. Connect the other end of the Limiter to the U1J1 connector of the Microwave Module.

NOTE

When installing the Limiter in the 5350A (only), the Limiter may be installed pointing in either direction.

- h. Tighten the SMA connections at both ends of the Limiter, using a 5/16 inch wrench. **DO NOT OVERTIGHTEN** the SMA connections.
- i. Insert the Microwave Module back into the front panel assembly, and reinstall the front panel assembly into the instrument frame. (Refer to reassembly procedures in Section VIII.)
- j. Screw the H12 knurled nut onto the INPUT 1 connector, and carefully tighten it with a 3/4 inch knurled nut driver.
- k. Replace the top cover.
- l. Perform the tests described in Section IV, Performance Tests to verify that the instrument meets the Option 006 specifications in *Table 1-1*.

2-47. To install Option 006 for the 5351A, proceed as follows:

- a. Disconnect ac power from the instrument.
- b. Remove the top cover.
- c. Remove the front panel assembly, with the attached Microwave Module, from the front frame of the instrument. (Refer to the disassembly procedures in Section VIII.)
- d. Using a 0.062 inch Allen wrench, loosen 3 set-screws securing the connector collar (MP37) to the INPUT 1 APC-3.5 connector. Remove the collar and the knurled nut (H12) from the INPUT 1 connector. Separate the Microwave Module from the front panel assembly.

- e. Disconnect the W11 semi-rigid input cable from the Microwave Module, using a 5/16 inch wrench. Once disconnected from the Microwave Module, the W11 cable and the INPUT 1 connector (consisting of connector assembly J1, and threaded spacer MP38) can be removed from the Microwave Module mounting bracket.
- f. Disconnect the W11 cable from the INPUT 1 connector, and loosen the J1 connector assembly from the MP38 threaded spacer, using a 5/16 inch wrench. Unscrew the connector assembly from the spacer, and replace it with the Microwave Limiter (AT1). Tighten the Limiter firmly with the wrench.

NOTE

When installing the Limiter in the 5351A (only), the Limiter can be inserted only one way, due to the flange on the Limiter. The Limiter must be screwed in from the larger end of the spacer, opposite the externally threaded end.

- g. Reconnect the W11 cable to the INPUT 1 connector, and reinsert the connector into the rectangular hole in the mounting bracket.
- h. Connect the other end of the semi-rigid cable to the SMA connector of the Microwave Module (U1J1). Tighten all SMA connections with the 5/16 inch wrench.
- i. Insert the Microwave Module back into the front panel assembly, and reinstall the front panel assembly into the instrument frame. (Refer to reassembly procedures in Section VIII.)
- j. Screw the H12 knurled nut onto the INPUT 1 connector, and tighten with a 3/4 inch knurled nut driver. Place the MP37 connector collar onto the connector and tighten the 3 set-screws.
- k. Replace the top cover.
- l. Perform the tests described in Section IV, Performance Tests to verify that the instrument meets the Option 006 specifications in *Table 1-1*.

2-48. Installation of Combined Options 002/006

2-49. The Option 002 Rear Panel Inputs can be combined with the Option 006 Limiter in both the 5350A and 5351A. In general, the combined options are installed using procedures similar to the Option 002 installation procedures, with some modifications.

2-50. To install combined Options 002/006 for the 5350A, proceed as follows:

- a. Disconnect ac power from the instrument.
- b. Remove the top cover.
- c. Remove the front panel assembly, and the attached Microwave Module, from the front frame of the instrument. (Refer to the disassembly procedures in Section VIII.)
- d. Unscrew the knurled nut (H12) from the INPUT 1 type-N connector on the High Frequency Input Cable (W6), and separate the Microwave Module from the front panel assembly.

- e. Disconnect the W6 input cable from the Microwave Module, using a 5/16 inch wrench to loosen the SMA connector. Set the W6 cable aside, as it is not used to install combined Options 002/006.
- f. Connect the Microwave Limiter (AT1) to the Option 006 Input Cable (W10) and finger-tighten the connection only a turn or two. DO NOT TIGHTEN the SMA connection all the way.

NOTE

When installing the Limiter in the 5350A (only), the Limiter may be installed pointing in either direction.

- g. Remove the metal plugs (MP3, MP4) covering the two rear panel input holes, and insert the type-N connector of the W10 cable into the larger of the two holes. Loosely screw the H12 knurled nut onto the connector from the outside of the rear panel. DO NOT TIGHTEN the nut at this time.
- h. Remove the 9/16 inch hex nut (H27) and lockwasher (H16) which secure the INPUT 2 BNC connector to the front panel. Remove the INPUT 2 connector from the front panel and install it in the appropriate hole in the rear panel, securing it with the H27 hex nut and H16 lockwasher. Reconnect the A2W1 coaxial cable (disconnected during removal of the front panel assembly) to the INPUT 2 connector. The A2W1 cable should be routed through the cutout in the card cage strut next to the T1 transformer.
- i. Take the 5350A Rear Panel Input Cable (W9) and insert it through the cutout in the card cage strut. The hook-shaped end of the cable should be nearer to the front panel.
- j. Connect the W9 cable to the Microwave Limiter, finger-tightening the SMA connection only a turn or two. DO NOT TIGHTEN the connection all the way.
- k. Place the Microwave Module in its normal location in the instrument, and connect the W9 cable to the Microwave Module SMA connector (U1J1). DO NOT TIGHTEN the connection all the way.
- l. Reinstall the front panel assembly, being careful to keep the semi-rigid cables properly aligned. (Refer to reassembly procedures in Section VIII.) Insert the metal plugs which were removed from the rear panel input holes into the front panel input holes.
- m. Tighten all SMA connections, using a 5/16 wrench. The Microwave Module connector should be tightened first, followed by the connectors at both ends of the Limiter. DO NOT OVERTIGHTEN the SMA connectors. Finally, tighten the knurled nut on the rear panel INPUT 1 connector, using a 3/4 inch knurled nut driver.
- n. Replace the top cover.
- o. Perform the tests described in Section IV, Performance Tests to verify that the instrument meets the Option 002 and Option 006 specifications in *Table 1-1*.

2-51. To install combined Options 002/006 in the 5351A, follow the Option 002 installation procedure beginning at paragraph 2-43 but replace subparagraph “f” and “o” in the Option 002 procedure with the following subparagraphs:

Replace subparagraph “f” with the following:

- f. Disconnect the W11 cable from the INPUT 1 connector and set the cable aside, as it is not used as part of the combined Options 002/006 installation. Disassemble the INPUT 1 connector by loosening the connector assembly (J1) from the threaded spacer (MP38), using a 5/16 inch wrench. Unscrew the connector assembly from the spacer, and replace it with the Microwave Limiter (AT1). Tighten the Limiter firmly with the wrench.

Replace subparagraph “o” with the following:

- o. Perform the tests described in Section IV, Performance Tests to verify that the instrument meets the Option 002 and Option 006 specifications in *Table 1-1*.

SECTION III OPERATION AND PROGRAMMING

3-1. INTRODUCTION

3-2. This section contains the operating and programming information for the HP 5350A, 5351A and 5352A Microwave Frequency Counters. Also included are descriptions of all front panel and rear panel connectors, indicators and controls, operator's checks, local and remote operating instructions, and operator's maintenance.

3-3. The information contained in this section is organized as follows:

- a. Operating Characteristics, paragraph 3-4: Overall description of the HP 5350A/51A/52A performance capabilities.
- b. Initial Power-Up Self Tests and Diagnostics, paragraph 3-60: Description of automatic internal checks performed by the instrument at power-up.
- c. Front Panel Features, paragraph 3-64: Detailed description of the operation of each front panel key and control, the front panel display, and the function of each display annunciator.
- d. Rear Panel Features: paragraph 3-116: Detailed description of the operation of each rear panel control and connector.
- e. Operator's Maintenance, paragraph 3-134: Maintenance performed by the operator to assure proper instrument operation.
- f. Operator's Checks, paragraph 3-140: Quick procedures to verify that the instrument is operating properly. Also included is a brief description of failure, error, and warning messages which may appear on the front panel display, indicating a disallowed operation or a possible instrument failure.
- g. Operating Procedures, paragraph 3-162: Detailed procedures for each specific measurement mode, including use of all measurement modifiers and auxiliary functions.
- h. Remote Programming via HP-IB, paragraph 3-225: Overall description of HP 5350A/51A/52A programming capabilities.
- i. HP-IB Command Codes, paragraph 3-275: Descriptions and definitions of codes used to program the counter for remote operation.
- j. Programming Examples, paragraph 3-361: Specific examples of HP 5350A/51A/52A programs and their applications.

3-4. OPERATING CHARACTERISTICS

3-5. The following paragraphs contain brief descriptions of the functions and characteristics of the HP 5350A, 5351A and 5352A. When discussing counter features and specifications, the information given will always apply to all three models unless otherwise indicated. Refer to paragraph 1-7 for a description of the terminology used in this manual to describe the three models collectively and individually.

3-6. Overall Description

3-7. The HP 5350A is a CW microwave frequency counter with a measurement range of 10 Hz to 20 GHz. The HP 5351A and 5352A counters are similar to the 5350A, with the 5351A having an extended measurement range of 10 Hz to 26.5 GHz, and the 5352A a range of 10 Hz to 40 GHz. Signals in the frequency range of 10 Hz to 80 MHz are measured by the direct count method, and signals in the range of 10 MHz to 525 MHz are measured by the prescaled count method. Signals in the frequency range of 500 MHz to MAX GHz are down-converted to an intermediate frequency (IF) by HP's harmonic heterodyne down-conversion technique. The counted IF is added to, or subtracted from, a multiple of the local oscillator (LO) frequency to determine the input frequency.

3-8. The HP 5350A/51A/52A measures frequencies above 500 MHz with automatic amplitude discrimination and user-selectable (normal or low) FM rate tolerance. Sample rate and resolution are adjustable in steps via front panel controls. An internal microprocessor performs all measurement calculations, taking into account the selected resolution, FM rate, and math functions. Measurements are displayed in a fixed point format on the front panel liquid crystal display, with the segments to the right of the numeric portion of the display used to display additional, alphanumeric information to the operator.

3-9. To maximize accuracy and resolution, the instrument's IF counting circuitry uses a reciprocal counting technique and analog interpolation. Since the HP 5350A/51A/52A uses the reciprocal counting technique, it always makes a period measurement of the down-converted IF, and then computes the IF using the reciprocal of the period measurement. Additional measurement accuracy is obtained through the use of analog interpolators to reduce the inherent one count uncertainty by compensating for time differences between the time base and input trigger events.

3-10. The HP 5350A/51A/52A is a fully HP-IB (IEEE Standard 488-1978) programmable instrument, capable of performing all operating functions via local or remote control. In addition to the basic measurement function, the counter provides the following convenient features:

Math Functions (offset, scale, and smooth) give the user the capability of manipulating measurement data. Refer to paragraphs 3-82, 3-84, and 3-85.

Diagnostics are available which perform various internal checks of the counter's circuitry to aid in service and troubleshooting. Auxiliary Functions (a subset of the diagnostic functions) are also available for checking various measurement parameters. Refer to paragraphs 3-92, 3-96, 3-215, and to the diagnostic descriptions in Section VIII.

3-11. Operating Ranges

3-12. There are two basic operating ranges: 10 Hz to 525 MHz, and 500 MHz to MAX GHz. Frequencies in the low range are measured directly or are prescaled, while frequencies in the high range are measured using HP's harmonic heterodyne down-conversion technique. Front panel function keys allow the user to select INPUT 1 for signals in the 500 MHz to MAX GHz range, and INPUT 2 for signals in the 10 Hz to 525 MHz range. Two function keys allow the user to select either AUTO or MANUAL measurement mode for INPUT 1 measurements. The low frequency input has two impedance modes. Two function keys allow the user to select either 50Ω or 1MΩ input impedance for the INPUT 2 fused BNC connector.

3-13. Resolution

3-14. The best case resolution is the value represented by the least significant digit (LSD) in the display. In the HP 5350A/51A/52A, a maximum resolution of 1 Hz can be selected using the RESOLUTION key, together with the front panel INCREMENT and DECREMENT (arrow) keys.

The displayed numerals of the measurement are grouped in four sections of three digits each for ease in determining GHz, MHz, kHz, and Hz placement. Asterisks or blanks are used as place holders to improve interpretation of the display, depending on the resolution. For example, a signal measured to 100 kHz resolution is displayed using asterisks, as shown below:

GHz	MHz	kHz	Hz
19	499	9**	*

- while a signal measured to 1 MHz resolution will be displayed using blanks, as shown below:

GHz	MHz	kHz	Hz
19	499		

3-15. When performing a low frequency, high impedance (INPUT 2, 1M Ω) measurement, the key labeled HIGH RESOL can be used to set a resolution greater than 1 Hz, up to .001 Hz. The resolution obtained will depend on the input frequency.

3-16. Refer to paragraph 3-88 for information on using the RESOLUTION key, and to paragraph 3-98 for information on using the HIGH RESOL key.

3-17. Automatic Mode

3-18. The automatic mode of operation is selected by pressing the AUTO key. Input signals in the 500 MHz-MAX GHz range are acquired, measured, and displayed automatically. When power is initially turned on, the instrument goes into this mode automatically. Refer to paragraph 3-105 for a description of the Automatic measurement mode.

3-19. Manual Mode

3-20. The manual mode of operation is selected by pressing the MANUAL key. To operate in this mode, input signals in the 1 GHz-MAX GHz range must be known to within 20 MHz (within 3 MHz in the 500 MHz-1 GHz range), and this frequency (called the Manual Center Frequency) must be specified prior to the measurement. After the MANUAL key has been pressed, the most recent measurement becomes the Manual Center Frequency, or the operator may select a Center Frequency by using the front panel entry keys. Refer to paragraphs 3-106 and 3-178 for detailed information on using the Manual mode.

3-21. Sample Rate

3-22. The Sample Rate function sets the dead time between the end of one measurement and the start of the next measurement. The duration of the measurement gate time is determined by the resolution selected. The sample rate is adjustable in steps using the SAMPLE RATE key together with the front panel INCREMENT and DECREMENT (arrow) keys. When the sample rate is set to the minimum (FAST), the counter will measure as frequently as possible. The other extreme (HOLD) will cause the counter to hold the last displayed measurement indefinitely, until the TRIGGER key is pressed. Refer to paragraphs 3-95 and 3-188 for detailed information on setting the sample rate.

3-23. FM Tolerance

3-24. The HP 5350A/51A/52A will measure carrier frequencies which are modulated in frequency, such as a microwave radio carrier. The FM tolerance specifies the worst case FM deviations and rates which can be present without affecting the counter's ability to acquire the signal. The counter averages out the deviations to measure the actual carrier frequency it can tolerate, up to a maximum deviation of 20 MHz peak-to-peak | 12 MHz peak-to-peak for the

5352A], at an FM rate equal to or greater than 1 kHz, when the counter is set for normal FM rate tolerance.

3-25. FM Rate Tolerance

3-26. The HP 5350A/51A/52A is capable of measuring FM signals having a rate of deviation lower than 1 kHz by using the FM Rate Tolerance function. The FM Rate Tolerance function allows selection of either Normal Rate or Low Rate. Most measurements can be made with the counter set to Normal Rate (for signals with a 1 kHz or greater rate of deviation). Lower FM rates can be tolerated in Normal Rate mode with a corresponding loss of FM deviation tolerance. (Refer to *Table 1-1, Specifications*, for derating specifications.) The Low Rate mode is only needed for relatively extreme cases. When the counter is set to Low Rate, a longer gate time is used for harmonic number determination. This allows measurements at FM rates below 1 kHz, as low as 45 Hz for the HP 5350A/5351A specified deviation of 20 MHz peak-to-peak, and the HP 5352A specified deviation of 12 MHz peak-to-peak.

3-27. AM Tolerance

3-28. The HP 5350A/51A/52A is capable of measuring a signal with any modulation index as long as the minimum signal level is greater than the sensitivity specification, and the maximum signal level is less than the maximum operating level specification.

3-29. Automatic Amplitude Discrimination

3-30. The HP 5350A/51A/52A automatically acquires and displays the highest level signal within its sensitivity range. The highest level signal must be at least 6 dB (typical) greater in amplitude than any signal within 500 MHz, and 20 dB (typical) greater than any signal, within 500 MHz to MAX GHz. This feature is useful for discriminating against spurious signals and harmonics.

3-31. Offset Frequencies

3-32. The Offset function allows the user to add or subtract a constant value to/from a frequency measurement. For example, when measuring a radio IF and knowing the LO, the counter can be set to display the RF input by entering the LO frequency as a positive offset. When tuning an oscillator to a specific frequency, it may be easier to enter the desired frequency as a negative offset and then tune the oscillator until the counter display reads zero. Offset frequencies are entered using the OFFSET key together with front panel number keys, or the LST FRQ (Last Frequency) key. Refer to paragraphs 3-82 and 3-194 for a detailed description of the Offset Frequency function.

3-33. Scale

3-34. The Scale function provides a means of multiplying the measured frequency by a scaling factor selected on the keyboard. The scaling factor is set using the SCALE key together with front panel number keys. When the factor is entered, the measured frequency is multiplied by this factor, and the resulting product is displayed by the counter. The Scale function can also be used together with the Offset Frequency function ($(F_{in} \times \text{Scale}) + \text{Offset}$). Refer to paragraphs 3-84 and 3-197 for detailed information on using the Scale function.

3-35. Smooth

3-36. The Smooth function provides a means of “smoothing” the display for easier reading, and is turned on or off by pressing the SMOOTH key. When the Smooth function is on, the counter displays only the digits that are relatively stable, and keeps a running average of the measurements to remove small deviations and increase displayed digits. Refer to paragraphs 3-85 and 3-199 for a detailed description of the Smooth function.

3-37. Self Check

3-38. As a quick operation verification, the user may press the SELF CHECK key. Self Check calls up diagnostic subroutines to test the measurement circuitry. Refer to paragraphs 3-96 and 3-208 for detailed information on the Self Check function.

3-39. Diagnostics

3-40. In addition to the Self Check function, the HP 5350A/51A/52A has a variety of user-callable diagnostic routines which perform various tests on the instrument for troubleshooting and general information. The diagnostic mode is turned on by pressing the DIAGNOSTICS key, and a particular diagnostic may be selected using the DIAGNOSTICS key together with front panel number or arrow keys. Refer to paragraphs 3-92 and 3-204 for detailed information on using the diagnostic functions.

3-41. Remote Operation

3-42. The HP-IB connector on the rear panel of the counter is compatible with the HP 10833A/B/C/D HP-IB cables, allowing the HP 5350A/51A/52A to be operated remotely within a Hewlett-Packard Interface Bus system. In remote operation, all counter functions normally available by front panel control (except POWER and STBY) are also available via HP-IB. The HP-IB system allows interconnection of up to 15 HP-IB compatible instruments (including the controller). The HP-IB connectors have identical "piggyback" connectors on both ends so that several cables can be connected to a single source without special adapters or switch boxes. System components and devices may be connected in virtually any configuration desired. Refer to paragraph 2-19 for interconnection data concerning the HP 5350A/51A/52A rear panel HP-IB connector, and for restrictions on the Hewlett-Packard Interface Bus connection.

3-43. Characteristics With Options Installed

3-44. The operating characteristics of the HP 5350A/51A/52A are affected by the addition of any of the options described in the following paragraphs. Refer to *Table 1-1* for all option specifications.

3-45. Option 001 Oven Oscillator Timebase

3-46. With the addition of the Option 001 Oven Oscillator, temperature and line voltage variations are reduced, and short-term stability and aging rate are improved. Improved aging allows extended calibration periods. The oven temperature is maintained when the HP 5350A/51A/52A POWER switch is in either the ON or STBY position (provided that ac power is connected to the instrument). When the OVEN annunciator on the front panel display is lit, the oscillator is warming. When the oven is at the proper temperature, the OVEN annunciator goes out.

3-47. Option 002 Rear Panel Inputs

3-48. Option 002 provides rear panel inputs for both INPUT 1 and INPUT 2 in place of the front panel connectors on the 5350A and 5351A. The rear panel inputs are used for all the same functional modes of operation as the front panel inputs. The specifications listed in *Table 1-1* are the same as for the front panel inputs, except for the sensitivity specifications listed under Option 002 Rear Panel Inputs. When equipped with Option 002, the HP 5350A INPUT 1 sensitivity is 1 to 2 dB less than the standard instrument, and the HP 5351A INPUT 1 sensitivity is 1 to 3 dB less, depending on frequency.

3-49. Option 006 Limiter

3-50. Option 006 provides additional input protection for the HP 5350A and 5351A by the insertion of a limiter between the front panel high frequency connector (INPUT 1) and the input circuitry. Option 006 increases the damage level specification of the instrument, as listed in *Table 1-1* under Option 006 Increased Damage Level. An HP 5350A/5351A equipped with Option 006 will have its damage level increased by about 10 to 14 dB, depending on frequency.

3-51. Option 010 High Stability Timebase

3-52. The addition of the Option 010 High Stability Oven Oscillator improves the aging rate over that of the Option 001 Oscillator, allowing further extended calibration periods of up to five years. The oven temperature is maintained in exactly the same way as for the Option 001 Oscillator, and the OVEN annunciator on the front panel display performs identically, lighting when the oven is warming, and going out when the oven is at the proper temperature.

3-53. MAXIMUM INPUT SIGNAL POWER

3-54. High Frequency Input (INPUT 1)

CAUTION

Do not exceed +25 dBm (peak) of input power at the INPUT 1 connector (500 MHz-MAX GHz). Damage to the internal sampler may occur.

3-55. The HP 5350A/51A/52A will function within specifications for signal inputs up to +7 dBm in the 500 MHz-MAX GHz range. Under no circumstances should the input level to the HP 5350A/51A/52A exceed +25 dBm, peak. If the input power exceeds +25 dBm, damage to the internal sampler may occur. Measurements from +7 to +25 dBm are not recommended, as false readings may occur. When signal levels exceed +7 dBm, external attenuators should be used to attenuate the signal.

CAUTION

An overload indication may appear on the front panel display under high input signal conditions. A power meter or similar device must be used to ensure that the input signal level does not exceed INPUT 1 specifications. DO NOT DEPEND ON THE OVERLOAD INDICATION FOR THIS PURPOSE.

3-56. Low Frequency Input (INPUT 2)

3-57. The 10 Hz-525 MHz Low Frequency input BNC connector contains a fuse to provide protection from input levels which exceed the specified damage level for INPUT 2: 5.5V rms (+28 dBm). Refer to paragraph 3-134 for instructions on how to change the front panel fuse.

CAUTION

The INPUT 2 damage level described above is only a simplified form of the complete specification. Refer to Table 1-1 for the complete Damage Level specification for INPUT 2.

3-58. INPUT CABLE CONSIDERATIONS

3-59. Consideration should be given to input cable losses at higher frequencies. For example, a 6-foot length of RG-214/U coaxial cable has about 15 dB loss at 18 GHz. Such losses must be taken into consideration along with the sensitivity specifications given in *Table 1-1*.

3-60. INITIAL POWER-UP SELF TESTS AND DIAGNOSTICS

3-61. An automatic internal check (Power-Up Self Test) is made of several major components, including the microprocessor and related circuitry, when the counter is powered-up. During the power-up cycle, the display will first show all segments and annunciators lit, and then the current HP-IB address. At the same time, the instrument proceeds through a set of diagnostic routines to verify instrument operation, including both analog and digital circuit verification.

3-62. During the Power-Up Self Test cycle, the HP 5350A/51A/52A performs the following:

- a. A front panel display routine is performed, during which all LCD segments and annunciators are lit for about 3 seconds, allowing visual verification by the operator.
- b. The microprocessor performs a RAM check, initializes the counter's measurement circuitry, initializes RAM, and then performs a ROM check.
- c. A Self Test sequence is performed which verifies proper operation of the timebase oscillator, the counting circuitry (including interpolators), the LO and IF circuitry, and the low frequency input circuitry.
- d. The HP-IB interface is checked, and the address is read from the rear panel switch and displayed. (If the counter is powered-up from Standby, the last address entered via the front panel keyboard is recalled.)
- e. The current instrument status is checked, and the front panel annunciators are restored accordingly. A check is made for the presence of an external reference, and for overload, HOLD, and lockout conditions. The front panel annunciators are updated, if necessary.
- f. The Diagnostic number is set to 1, diagnostic mode OFF, and the counter begins a measurement.

3-63. If any of the tests during the Power-Up Self Test fail, a failure message will be displayed and remain until the RESET/LOCAL key is pressed, causing the next test to be executed (if possible). In this way, a failure may be bypassed to allow the counter to perform all of the power-up diagnostics.

3-64. FRONT PANEL FEATURES

3-65. The front panel features of the HP 5350A/51A/52A are shown in *Figure 3-2*. General information on the front panel keyboard begins at paragraph 3-66, and a complete description of all the keys and their functions begins at paragraph 3-76. A detailed description of the front panel display and annunciators begins at paragraph 3-109.

3-66. Keyboard

3-67. The front panel keyboard contains 17 push-button switches for inputting commands to the microprocessor. The keyboard is used for function selection and data entry. The keyboard switches consist of a RESET/LOCAL key, a SET/ENTER key, three MATH keys, and twelve FUNCTION/DATA keys, as shown in *Figure 3-2*.

3-68. All keys on the keyboard, except RESET/LOCAL and SET/ENTER, play the dual roles of function selection and parameter (data) entry. Function selection assignments are labeled above each key on the front panel and the data entry assignments are labeled to the left of each key. Refer to *Table 3-1* for a summary of all key assignments. With a few exceptions (shown in lower case), the assignment names in the table are shown exactly the way they appear on the front panel¹

Table 3-1. Key Assignments

Function Assignment	Data Entry Assignment
AUTOMatic	3
MANUAL	±(change sign)
50Ω	9
1MΩ	6
RESOLUTION	7
DIAGNOSTICS	1
FM RATE TOLerance	2
SAMPLE RATE	0
HP-IB ADDRESS	4
SELF CHECK	8
TRIGGER	.
OFFSET	LST FRQ (last frequency)
SCALE	→ INC (increment)
SMOOTH	← DEC (decrement)
HIGH RESOLution	5

3-69. After pressing the SET/ENTER key and selecting a function which requires data entry, such as OFFSET, the user is prompted by the display and the keyboard becomes a numeric entry pad. Numeric entry is terminated by pressing the SET/ENTER key a second time. In the OFFSET mode, entry of the last measurement as an offset is simplified by the LST FRQ key; this function sets the frequency offset as the negative of the last measurement. The LST FRQ key can also be used to set the manual center frequency to the last measurement.

3-70. Keyboard Memory

3-71. Whenever the instrument is set to Standby, the microprocessor automatically stores the front panel settings, as long as the instrument is connected to an ac power source. When the instrument is turned back on, it will be set to the last front panel settings. This avoids having to re-enter math constants, functions or data, whenever the instrument is switched to Standby. If ac power is applied to the counter just prior to turn-on, all function parameters will be initialized to their power-up default values. Parameter value ranges and default values are shown in *Table 3-2*.

Table 3-2. Parameter Values

Parameter	Range of Values	Power-up Values	Standby
Measurement Mode	Auto, Manual, 50Ω, 1MΩ	Auto	saved
Manual Center Frequency	500 MHz to 45 GHz On, Off	1 GHz, Off	saved
Offset Frequency	±0 Hz to 999.9.. GHz On, Off	0 Hz, Off	saved
Scale Factor	±0.0001 to 9999 On, Off	1.000, Off	saved
Smooth	On, Off	Off	saved
Sample Rate	Fast, 0.5s, 1.5s, 3s, 5s, 10s, Hold	Fast	saved
Resolution	1 Hz, 10 Hz, 100 Hz, 1 kHz, 10 kHz, 100 kHz, 1 MHz	1 Hz	saved
HP-IB Address	0 to 31	Rear panel switch	saved
Diagnostics	1 to 99 On, Off	1, Off	1, Off
FM Rate Tolerance	Normal, Low	Normal	saved
High Resolution	On, Off	Off	saved

3-72. Entering Parameter Values

3-73. Parameter value entry is always initiated by pressing the SET/ENTER key once, and terminated by pressing the SET/ENTER key a second time. When entering a parameter value, the entire sequence may be aborted at any time by pressing the RESET/LOCAL key. The counter then returns to the state it was in before the SET/ENTER key was pressed.

3-74. After the SET/ENTER key has been pressed once, the display shows "SET", and the counter waits for a function key to be pressed. After the SET/ENTER and the function key have been pressed, the keyboard is in the "parameter entry mode", and the data entry assignment of each key is accessible. (Refer to *Table 3-2.*) The response to each key depends on the specific function involved. The INC (increment) and DEC (decrement) keys will repeat if held down. The function name appears in the right hand portion of the display during entry of the parameter value. Refer to paragraph 3-162, Operating Procedures.

3-75. Certain parameter values, such as offset frequencies or scale factors, are entered as numeric data, using the Function/Data keys. Other parameter values can be selected from a specific range using the INC (increment) and DEC (decrement) keys, as with the Sample Rate and Resolution parameters. Still other parameters are simply toggle functions, as for example the Smooth or FM Rate Tolerance parameters. If the user should attempt to enter the incorrect type of data as a parameter value, the counter will display either "PLEASE USE ARROW KEYS" or "PLEASE USE DIGIT KEYS" to indicate the type of data entry required. If data entry is attempted for a toggle function, the counter will display "TOGGLE FUNCTION ONLY".

3-76. Key Functions

3-77. The following paragraphs explain the primary function of each of the 17 keys in the front panel keyboard. Three of the keys, OFFSET, SCALE, and SMOOTH, are grouped together in the MATH section, and the remaining keys, except for RESET/LOCAL and SET/ENTER, are grouped

together in the FUNCTION/DATA section. The location of each key is shown in *Figure 3-2*. Refer to paragraph 3-162, Operating Procedures, for examples of how to use each of the major functional modes of the HP 5350A/51A/52A.

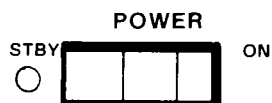

3-78. **POWER.** When the POWER switch is in the ON position, power is supplied to the entire instrument. The STBY (Standby) position removes normal operating power to the instrument, but supplies power for certain microprocessor and timebase circuits, as well as for the Option 001 and 010 oven oscillators to maintain a constant temperature for the crystal. The STBY LED indicator located to the left of the POWER switch will remain on when the switch is in the standby position. The input to the power transformer, and dc voltages to the microprocessor standby RAM, the timebase buffer, and the oscillator oven circuitry are always energized whenever power is connected, whether the POWER switch is set to ON or STBY.

WARNING

BEFORE APPLYING AC POWER, THE INSTRUMENT AND ALL PROTECTIVE EARTH TERMINALS, EXTENSION CORDS, AUTO-TRANSFORMERS, AND DEVICES CONNECTED TO THE INSTRUMENT SHOULD BE CONNECTED TO A PROTECTIVE EARTH GROUNDED SOCKET. ANY INTERRUPTION OF THE PROTECTIVE EARTH GROUNDING WILL CAUSE A POTENTIAL SHOCK HAZARD THAT COULD RESULT IN PERSONAL INJURY.

3-79. The rear panel reference outputs are still available when the instrument is in the standby mode, and the state of the instrument is saved as long as ac power is connected to the instrument. All parameter and function settings are stored in the processor standby RAM.

RESET / LOCAL



3-80. **RESET/LOCAL.** This key is generally used to abort any current activity to return to counting, and will restart a measurement if the counter is already in the measurement mode. Pressing RESET/LOCAL will clear any Error messages which may appear, and will also exit the Self Check or diagnostics modes. When entering data via the front panel keyboard, pressing RESET/LOCAL aborts any partially entered sequence, and the counter returns to the current measurement mode. If the counter is in diagnostics mode, RESET/LOCAL will abort the diagnostic, and return the counter to the current measurement mode.

3-81. If the instrument is in the remote operating mode, then the RESET/LOCAL key also acts as a "return to Local" key. It is the only active key when the counter is in the remote mode, and may be disabled using the "Local Lockout" HP-IB function, or the "Keyboard Lockout" diagnostic (Diag 98). (Refer to diagnostic descriptions in Section VIII, Service.)



3-82. **OFFSET.** This function allows the user to enter a signed, constant frequency value which will be automatically added to each measurement. When the OFFSET key is pressed, the current offset value is displayed until the key is released, after which the counter continues measuring, displaying the sum of the input frequency plus the offset. A negative offset is displayed with a minus sign immediately to the left of the digits.

For a positive offset, a blank is displayed to the left of the digits. Changing the sign may be done at any time during parameter entry, and the sign may be toggled as many times as the user wishes. The offset is entered in megaHertz, down to 1 Hz resolution. After the decimal point is pressed, subsequent digits are displayed to the right of the 1 MHz position in the parameter section. The final, entered offset is displayed with no decimal point, as it is fixed-point notation. To turn off the offset, press the OFFSET key again.

3-83. The offset value may be entered using the Function/Data keys or by pressing the LST FRQ (Last Frequency) key. When using the LST FRQ key, the offset is set to the negated value of the last frequency measured, exclusive of any math function that may be active.

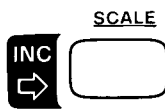

3-84. **SCALE.** This function allows the user to enter a signed, dimensionless constant to be used as a multiplication factor. Pressing the SCALE key turns on the Scale function, and the current scale value is displayed until the SCALE key is released. After the key is released, the counter continues measuring, displaying the product of the measured frequency multiplied by the scale factor. When combined with the Offset function, the counter will automatically compute and display the following:

$$[(F_{in}) \times (SCALE)] + OFFSET$$

To turn off the Scale function, press the SCALE key again.

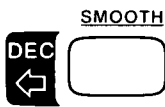

3-85. **SMOOTH.** Pressing the SMOOTH key initiates the “automatic resolution” algorithm, causing the counter to display only the digits that are stable. The input frequency is averaged to remove small deviations and increase resolution, and the unstable digits are masked in the same manner as the RESOLUTION display. Pressing the SMOOTH key a second time disables the Smooth function. There is no data entry associated with this function.

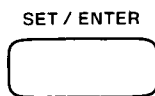

3-86. **SET/ENTER.** This key is used for parameter value entry for various keyboard functions. Parameter value entry is always initiated by pressing the SET/ENTER key once, after which the counter will display “SET”. The counter then waits for a function key to be pressed. After a function key has been pressed, the keyboard is in the “parameter entry mode”, and the data entry assignment of each key is accessible (Refer to *Table 3-2*). Parameter entry is terminated by pressing the SET/ENTER key a second time (entering the value into memory).

3-87. When setting a parameter value, the entire sequence may be aborted at any time by pressing the RESET/LOCAL key. The counter will then return to the state it was in before the SET/ENTER key was pressed.



3-88. **RESOLUTION.** This function allows the user to change the number of significant digits displayed after measurements. A higher resolution results in a longer gate time; the lower the resolution, the shorter the gate time. This parameter may be varied from 1 Hz (highest resolution) to 1 MHz (lowest resolution) using the INC (increment) and DEC (decrement) keys, in decade steps. Since the minimum gate time is 1 millisecond, resolutions of less than 1 kHz change only the displayed resolution, not the measurement time.

3-89. The current setting of the resolution may be displayed while counting by pressing the RESOLUTION key. It will remain displayed until the key is released. The nonsignificant digits of a measurement are rounded off and, in the display, are either blanked or replaced by the asterisk symbol $*$, depending on the resolution.



3-90. **HP-IB ADDRESS.** This key allows the user to display and set the HP-IB address. At power-up, after reapplication of ac power, the HP-IB address of the counter is determined by the switch settings on the HP-IB board (rear panel address switch). Pressing the HP-IB ADDRESS key will display the current address until the key is released, after which the instrument resumes counting. The current address can be changed by going to the parameter entry mode (using the SET/ENTER key). Addresses 0 through 30 are valid bus addresses. Address 31 is used to set the counter to the TALK ONLY mode.

3-91. If the counter is switched to STBY and then back to ON, it will remain set to the HP-IB address entered via the front panel keyboard. If the ac power source to the instrument is disconnected and then reconnected, the instrument will default to the address determined by the setting of the rear panel address switch.



3-92. **DIAGNOSTICS.** This function key allows the user to call up diagnostic routines which perform various tests on the instrument for troubleshooting and measurement information. Pressing the DIAGNOSTICS key once turns on the diagnostic function, and the counter will carry out the current diagnostic routine. The current diagnostic will be that which was last entered by the user, or if the counter has just been turned on, the diagnostic will default to Diag 1. To exit the diagnostic mode, press the DIAGNOSTICS key a second time, or press the RESET/LOCAL key.

3-93. The user may enter a new diagnostic number (from 1 to 99) in the parameter entry mode, using the Function/Data keys for numeric entry. Most of the diagnostics may also be entered using the INC (increment) and DEC (decrement) keys. Other instrument functions may be set up while in diagnostic mode (for example, measurement modes, resolution, etc.). Refer to the diagnostic descriptions in Section VIII, Service.

3-94. There are 37 user-callable diagnostics available for testing instrument circuitry. Since not all of the numbers between 1 and 99 are used, the counter will show a "NOT AVAILABLE" message on the display if the user should attempt to enter an invalid diagnostic number. To get out of a "NOT AVAILABLE" diagnostic condition, the operator may use the INC or DEC keys to move to the nearest valid diagnostic number, or use the SET/ENTER key sequence to enter a valid number. The Diagnostic mode may also be exited as described previously, using the DIAGNOSTICS or RESET/LOCAL key.



3-95. **SAMPLE RATE.** This function sets the dead time between measurements. The minimum time (Fast) allows the counter to count as frequently as possible. The other extreme (Hold) will keep the last measurement until the TRIGGER key is pressed to start a new measurement. When in "Hold", the HOLD annunciator is lit. While setting the sample rate, the GATE annunciator flashes at the currently selected sample rate. Pressing the SAMPLE RATE key while the instrument is

counting causes the current sample rate to be displayed until the key is released, after which the counter returns to counting.



3-96. **SELF CHECK.** As a quick operation verification, the user may press the SELF CHECK key. Self Check calls up a sequence of diagnostic subroutines to test the measurement circuitry. The tests have been ordered such that no test depends on more than one untested circuit assembly.

3-97. If the Self Check passes, a "PASS" message is displayed for about 3 seconds, and the counter returns to the measurement cycle. If Self Check fails, a "FAIL" message is displayed. After a failure, the Self Check sequence restarts and the failure message will continue to be displayed. Self Check failures may be bypassed by pressing the RESET/LOCAL key. The remaining tests in the Self Check sequence will be carried out, until another failure occurs, or the last test is completed. If any failure occurs, the last "FAIL" message (after the last test is done) will include the word "SELF" at the right end of the display. Pressing the RESET/LOCAL key again will return the counter to its previous measurement mode.



3-98. **HIGH RESOL.** This function allows the user to select a resolution greater than 1 Hz for measurements below 10 MHz. The High Resolution function applies only to INPUT 2, 1M Ω impedance measurements. Pressing the HIGH RESOL key once turns on the function, and the HIGH RESOL annunciator will light. Since this function is active only in the 1M Ω Low Frequency measurement mode, the HIGH RESOL annunciator will NOT light when the counter is in the Auto, Manual, or 50 Ω measurement mode. Pressing the key a second time will turn off the High Resolution function. There is no data entry associated with this function.

3-99. The resolution obtained using the High Resolution function depends on the input frequency, and the gate time will remain constant at 1 second. The Smooth function takes precedence over the High Resolution function. The High Resolution function takes precedence over the standard counter resolution, if the counter is in the INPUT 2, 1M Ω measurement mode.

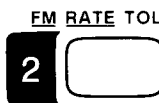

3-100. **FM RATE TOLERANCE.** The FM Rate Tolerance function applies only when using the INPUT 1, AUTO mode, to select the acquisition method to compensate for very low rates of frequency modulation during high frequency measurements. Pressing the FM RATE TOL key toggles the function between two states: Normal Rate and Low Rate. When set to Low Rate, the measurement gate time of the counter is increased to ensure an accurate measurement of signals with FM rates lower than 1 kHz, and high deviation.

3-101. One of two front panel annunciators (FM NORM and FM LOW) will light to indicate which FM mode is currently selected when in Auto mode. When the instrument is not in Auto mode, neither of the annunciators will appear. There is no data entry associated with this function.



3-102. **TRIGGER.** When the counter sample rate is set to HOLD, pressing the TRIGGER key starts a new measurement. There is no data entry associated with this function.

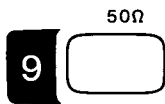

3-103. **50Ω**. This key selects the Low Frequency, 50Ω input mode (INPUT 2) for measuring low frequency (10 MHz to 525 MHz) signals from 50Ω sources. Pressing the 50Ω key turns on this mode, and disables the INPUT 1 high frequency circuit by turning off the A12 Microwave Assembly. The measured frequency will be displayed in the parameter section of the display; the message section will be blank. To exit the 50Ω mode, press one of the three other measurement mode keys (AUTO, MANUAL, 1MΩ); pressing the 50Ω key a second time has no effect. There is no data entry associated with this key.

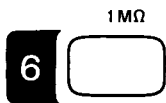

3-104. **1MΩ**. This key selects the Low Frequency, 1MΩ input mode for measuring frequencies from 10 Hz to 80 MHz. Pressing the 1MΩ key turns on this mode, and disables the INPUT 1 high frequency circuit by turning off the A12 Microwave Assembly. The measured frequency will be displayed in the parameter section of the display; the message section will be blank. To exit the 1MΩ mode, press one of the other measurement mode keys; pressing the 1MΩ key again has no effect. There is no data entry associated with this key.

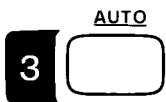

3-105. **AUTO**. The instrument powers-up in the automatic measurement mode, and the AUTO annunciator on the front panel will be lit. In this mode, the counter will automatically acquire and measure the signal at INPUT 1. Measurements are displayed in the parameter section of the display; the message section of the display remains blank, or displays "OVRLOAD" if an overload condition exists. To exit the Auto mode, press one of the other measurement mode keys; pressing the AUTO key a second time has no effect. There is no data entry associated with this key.



3-106. **MANUAL**. A Center Frequency (CF) must be specified for the counter to measure when in this mode. To enter this mode, press MANUAL. The most recent measurement will then become the Manual Center Frequency. The CF will be displayed until the key is released, then the counter will begin counting in Manual mode. The measured frequency will be shown in the parameter section of the display; the message section will remain blank, or display "OVRLOAD" if an overload condition exists. To exit the MANUAL mode, press one of the other measurement mode keys; pressing the MANUAL key a second time has no effect.

3-107. To enter a center frequency, press the SET/ENTER key, then press MANUAL. The current center frequency is displayed, and may be changed. The CF may also be entered using the LST FRQ key. In this case, the CF is set to the value of the last measured frequency, exclusive of any math functions that may be active. Pressing the SET/ENTER key a second time enters the new CF into memory, and the counter will begin counting using the new value.

3-108. If a manual CF is entered which is greater than 33 GHz [43 GHz, 5352A] or less than 500 MHz, then an error is displayed. After the user clears the error, the counter returns to counting using the previous value. If a CF containing fractional-megaHertz values is entered, the fractional portion is truncated on pressing the SET/ENTER key. The CF entered should be no more than 20 MHz from the input frequency for inputs in the 1 GHz-MAX GHz range, and no more than 3 MHz from the input

frequency for inputs in the 500 MHz-1 GHz range. If the CF is too far from the input frequency, the counter may display an incorrect measurement.

3-109. Front Panel Display and Annunciators

3-110. All HP 5350A/51A/52A display functions are performed by a Liquid Crystal Display Assembly. Annunciation for all operating modes is indicated by arrows at the bottom of the display which, when lit, point to the function names marked on the front panel just beneath the LCD panel.

3-111. The front panel display consists of 24 LCD characters, as shown as shown in *Figure 3-1*. During measurement and parameter entry, the characters are divided into a parameter section, and a message section. The parameter display section has room for 12 digits, grouped in sets of three by blank characters between each group. The message section has 8 characters available, the first usually being blank to serve as a separator between the message section and the parameter section. The content of the display will be different for each operating mode. The various HP 5350A/51A/52A functions and their corresponding displays are described in the Operating Procedures beginning at paragraph 3-162.

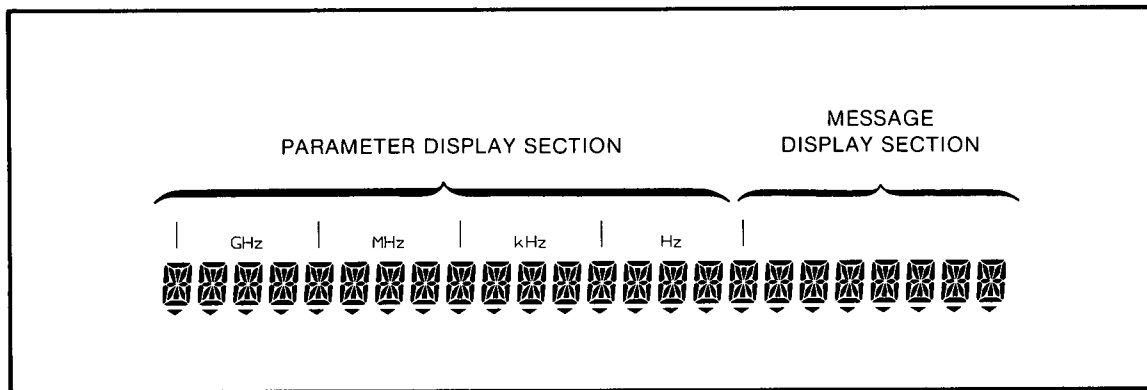

Figure 3-1. Liquid Crystal Display (LCD)

3-112. LCD Character Set

3-113. *Table 3-3* shows the set of all possible LCD characters which can be formed by the LCD Display. The equivalent ASCII and decimal codes are included for programming the remote display function available from the HP-IB. Refer to paragraph 3-225, Remote Programming via the HP-IB.

Table 3-3. LCD Character Set

LCD CHAR.	ASCII CHAR.	DECIMAL	LCD CHAR.	ASCII CHAR.	DECIMAL	LCD CHAR.	ASCII CHAR.	DECIMAL
	@	64		V, v	86, 118		,	44
	A, a	65, 97		W, w	87, 119		—	45
	B, b	66, 98		X, x	88, 120		.	46
	C, c	67, 99		Y, y	89, 121		/	47
	D, d	68, 100		Z, z	90, 122		0	48
	E, e	69, 101			91		1	49
	F, f	70, 102		\	92		2	50
	G, g	71, 103			93		3	51
	H, h	72, 104		^	94		4	52
	I, i	73, 105		—	95		5	53
	J, j	74, 106	space	space	32		6	54
	K, k	75, 107		!	33		7	55
	L, l	76, 108		“	34		8	56
	M, m	77, 109		#	35		9	57
	N, n	78, 110		\$	36		:	58
	O, o	79, 111		%	37		; {	59, 123
	P, p	80, 112		&	38		<,	60, 124
	Q, q	81, 113		'	39		=, }	61, 125
	R, r	82, 114		(40		>, ~	62, 126
	S, s	83, 115)	41		? , DEL	63, 127
	T, t	84, 116		*	42			
	U, u	85, 117		+	43			

3-114. Annunciator Descriptions

3-115. The various modes and functions of the HP 5350A/51A/52A are labeled on the front panel just beneath the LCD, as shown in *Figure 3-2*. When an operating mode or function is selected, an arrow-shaped annunciator (\blacktriangledown) appears at the lower edge of the display, pointing to the name of the selected mode or function. *Table 3-4* contains a brief description of each of the front panel annunciators.

Table 3-4. Front Panel Annunciator Descriptions

1)	GATE The GATE annunciator shows the status of the counter's gate. The GATE annunciator flashes during measurements to indicate the opening and closing of the gate.
2)	HOLD The HOLD annunciator lights when the sample rate of the counter has been set to the slowest possible rate. When in HOLD, the counter keeps the last measurement until a new measurement is triggered using the front panel TRIGGER key or the HP-IB TRIGGER or TRG command. The annunciator remains on until the sample rate is changed to a rate other than HOLD.
3)	OFFSET The OFFSET annunciator lights when the Offset Frequency function has been enabled. The displayed frequency will be that of the measured frequency plus the value of the entered offset frequency.
4)	SCALE The SCALE annunciator lights when the Scale function has been enabled. The displayed frequency will be that of the measured frequency multiplied by the scale factor.
5)	SMOOTH The SMOOTH annunciator lights when the Smooth function has been enabled. The frequency displayed will have unstable digits masked.
6)	REM The REM annunciator lights when the counter is under remote control. Refer to Remote Programming via the HP-IB, paragraph 3-225, for further information.
7)	LSN The LSN annunciator lights when the counter is addressed to listen. Refer to Remote Programming via the HP-IB, paragraph 3-225, for further information.
8)	TLK The TLK annunciator lights when the counter is addressed to talk, or when it is being used in the TALK ONLY mode. Refer to Remote Programming via the HP-IB, paragraph 3-225, for further information.

Table 3-4. Front Panel Annunciator Descriptions (Continued)

9) SRQ

The SRQ annunciator lights when a Service Request condition exists in the counter, requiring attention from the controller in charge of the HP-IB. Refer to Remote Programming via the HP-IB, paragraph 3-225, for further information.

10) OVEN

The OVEN annunciator lights if an optional oven oscillator installed in the instrument has not yet reached operating temperature (warming). The annunciator is always off if the standard oscillator is installed.

11) EXT REF

The EXT REF annunciator lights automatically when an external time base reference (1, 2, 5, or 10 MHz) is connected to the counter's rear panel external reference input. The annunciator goes out as soon as the external reference is disconnected.

12) FM NORM

The FM NORM annunciator lights when the counter's FM Rate Tolerance is set to Normal Rate. The annunciator goes out when the counter is set to Low Rate, or when the counter is not in AUTO mode.

13) FM LOW

The FM LOW annunciator lights when the counter's FM Rate Tolerance is set to Low Rate. The annunciator goes out when the counter is set to Normal Rate, or when the counter is not in AUTO mode.

14) AUTO

The AUTO annunciator lights when the counter is set to the Automatic measurement mode (INPUT 1). The annunciator goes out when another measurement mode is selected.

15) MAN

The MAN annunciator lights when the counter is set to the Manual measurement mode (INPUT 1). The annunciator goes out when another measurement mode is selected.

16) 50Ω

The 50Ω annunciator lights when the counter is set to the 50Ω Low Frequency mode (INPUT 2). The annunciator goes out when another measurement mode is selected.

17) 1MΩ

The 1MΩ annunciator lights when the counter is set to the 1MΩ Low Frequency mode (INPUT 2). The annunciator goes out when another measurement mode is selected.

18) HIGH RESOL

The HIGH RESOL annunciator lights when the High Resolution function is enabled and the counter is in the 1MΩ mode.

18 annunciators indicate the various modes and functions of the counter, such as gate status, math operations, HP-IB status, and measurement mode status. Small arrows beneath each character in the LCD light or blink, as required, to point to the name of an operating mode or function.

24-character Liquid Crystal Display performs all measurement and data display functions. During measurement and parameter entry, display is divided into a 12-digit parameter display section, and an 8-character message display section. In diagnostic mode, all 24 characters are used for alphanumeric display of information.

INPUT 2 BNC connector for input signals in the 10 Hz-595 MHz range is a special fused connector. The fuse (HP Part No. 2110-0381) is 1/8A, and is accessible (for replacement) from the front panel. 50Ω or 1MΩ input impedance for INPUT 2 is selectable via adjacent front panel keys.

PARAMETER DISPLAY SECTION

MESSAGE DISPLAY SECTION

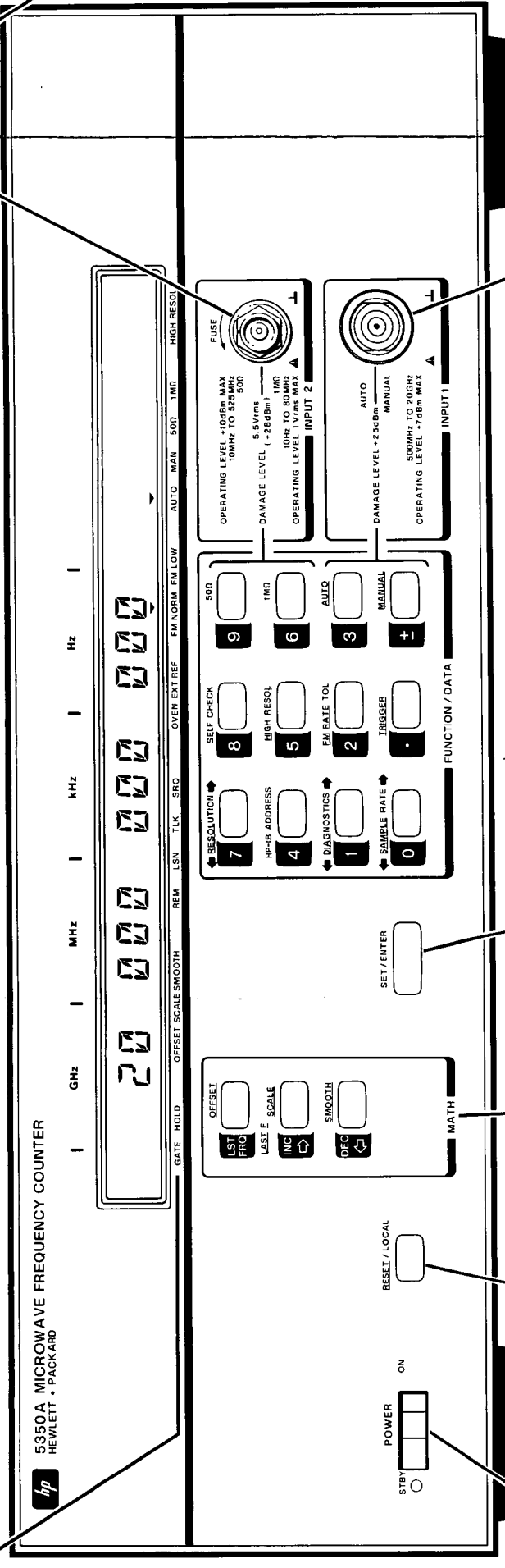

The POWER switch applies power to the entire instrument when set to ON. In STBY (Standby), power is applied only to the microprocessor internal RAM for data retention, and the optional oven oscillator (Option 001 or 010).

MATH keys provide post-measurement manipulation of displayed data via mathematical operations. OFFSET (±), SCALE (X), and SMOOTH (averaging). Math constants for OFFSET and SCALE functions are entered via the FUNCTION/DATA keys when MATH entry is enabled.

The RESET/LOCAL key aborts any current measurement or parameter entry activity, clears error messages, exits Self Check and diagnostic modes, and returns the instrument to local counting. Returns counter to local operation, if in remote.

FUNCTION/DATA keys provide one key per function selection of each measurement and operating mode. During parameter entry, the keys are reassigned to numeric or special entry values labeled to the left of each key.

SET/ENTER key is used for parameter entry for various keyboard functions. Pressing this key, and then a function key, sets the counter to accept numeric data entered via the FUNCTION/DATA keys. Parameter entry is terminated by pressing the SET/ENTER key a second time (entering the parameter values into memory).

HP 5350A INPUT 1 N-type connector for input signals in the 500 MHz-20 GHz range. Automatic and Manual measurement modes for INPUT 1 are selectable via adjacent front panel keys.

HP 5351A MICROWAVE FREQUENCY COUNTER

HP 5351A/5352A INPUT 1 APC 3.5 connector for input signals in the 500 MHz-26.5 GHz range (5351A), and the 500 MHz-40 GHz range (5352A). Automatic and Manual measurement modes are selectable as for the HP 5350A.

HP 5352A MICROWAVE FREQUENCY COUNTER

Figure 3-2. Front Panel Features

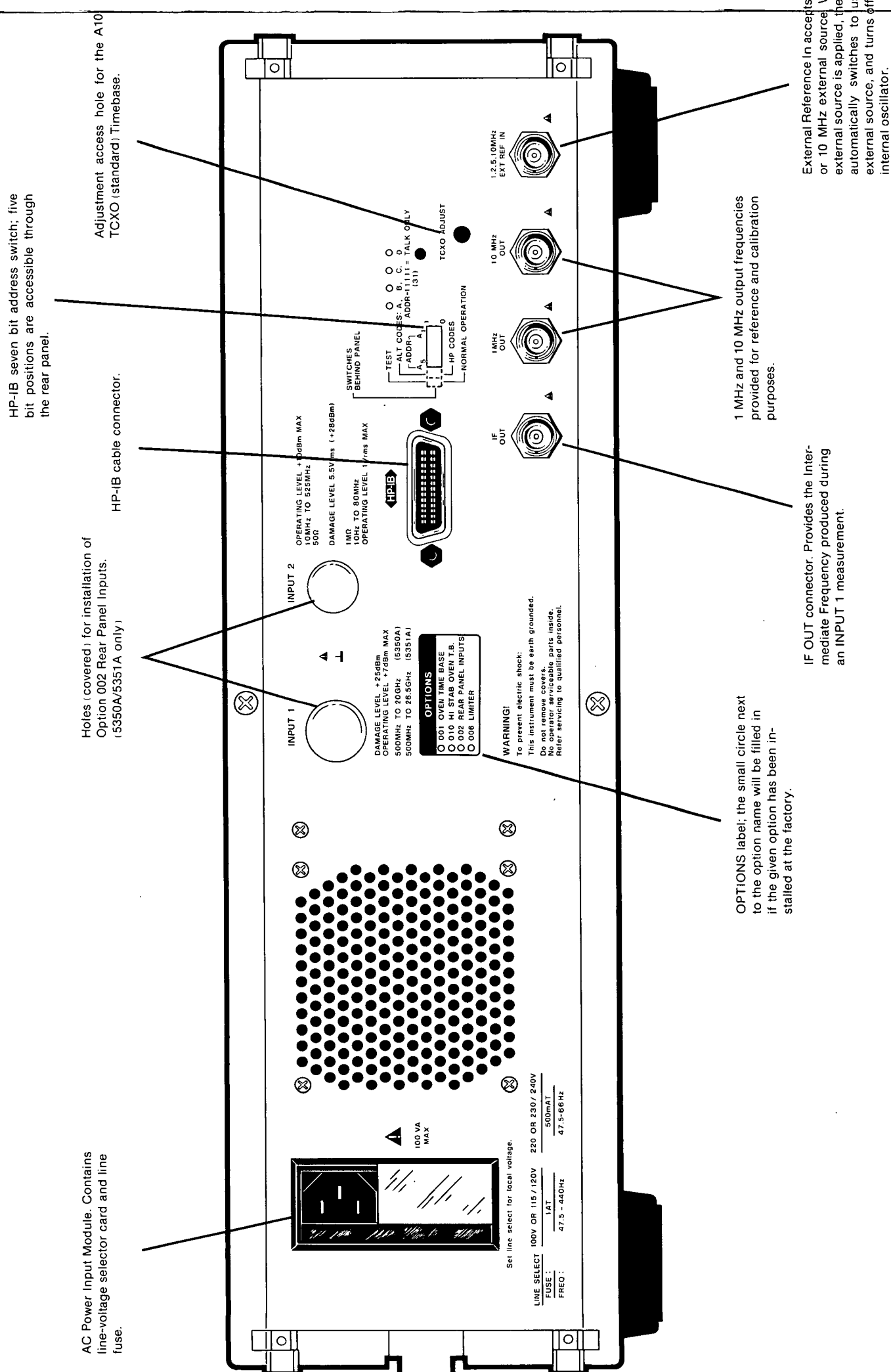

Figure 3-3. Rear Panel Features

3-116. REAR PANEL FEATURES

3-117. The following paragraphs describe the rear panel features of the HP 5350A/51A/52A. All rear panel features of the instrument are shown in *Figure 3-3*.

3-118. AC Power Input Module

3-119. The AC Power Input Module (A13) accepts the three-wire ac power cable (W1), permitting operation from 100-, 115/120-, 220-, and 230/240- volt ac sources. The power module contains a printed circuit line voltage selector card, which must be positioned to agree with the voltage of the power source. When the card is plugged into the module, the number visible in the module window indicates the nominal line voltage to which the instrument must be connected. The correct value line fuse must be installed after the card is inserted (Refer to Section II, paragraph 2-8, Line Voltage Selection, and *Figure 2-1* for further information). The protective grounding conductor connects to the instrument through this module.

3-120. TCXO Adjustment

3-121. This opening in the rear panel allows adjustment of the Temperature Compensated Crystal Oscillator standard timebase (but not the optional oven oscillators) without requiring removal of the instrument covers. Refer to Section V, Adjustments, for timebase calibration instructions.

3-122. HP-IB Connector

3-123. This input/output interface connector provides remote control capabilities with the Hewlett-Packard Interface Bus (HP-IB). For a complete description of the HP-IB capabilities, refer to paragraph 3-225, Remote Programming via the HP-IB.

3-124. HP-IB Address Switch

3-125. The HP-IB Interface Address Switch (ADDR) is a bank of seven switches used to manually set the remote control address of the counter. The five rightmost switch positions are externally accessible to the operator for setting the address. The two leftmost switch positions are not used for normal operation. For a complete description of address selection, refer to *Table 3-8* Address Selection in the Remote Programming instructions in this section.

3-126. External Reference In

3-127. An external reference input is provided for a 1 MHz, 2 MHz, 5 MHz, or 10 MHz reference source. If an external reference source is applied to this input, the counter automatically switches to using the external reference as its timebase, and turns off the TCXO standard timebase. If an oven oscillator is installed, power to the oven is maintained, but the internal oscillator signal is disconnected. A detection circuit in the timebase buffer sends a control signal to the microprocessor and the EXT REF display annunciator lights to indicate that an external source is being used. External reference requirements are listed in *Table 1-1, Specifications*.

3-128. 1 MHz Out, 10 MHz Out

3-129. Two rear panel signal outputs, 1 MHz and 10 MHz, are available for reference and calibration. The signals remain present when the instrument is in Standby and as long as ac power is connected to the instrument. Refer to *Table 1-1, Specifications* for the output signal specifications.

⚠ 3-130. IF Out

3-131. This output provides the IF signal resulting from the mixing of the input and LO harmonic frequencies for monitoring with a spectrum analyzer or oscilloscope. This signal is available only when a high frequency (INPUT 1) measurement is being made. Refer to *Table 1-1* for IF output specifications.

⚠ 3-132. Rear Panel Input Connectors (Option 002)

3-133. If Option 002 is installed in the 5350A or 5351A, the frequency inputs for the counter (INPUT 1, INPUT 2) are located on the rear panel, and covers are placed over the front panel openings. The rear panel inputs are used for all the same functional modes of operation as the front panel inputs. The performance specifications for the HP 5350A or 5351A equipped with Option 002 are listed in *Table 1-1, Specifications*.

⚠ 3-134. OPERATOR'S MAINTENANCE

3-135. The only maintenance the operator should normally perform is replacement (when necessary) of two fuses: the primary power fuse (F1) located within the AC Power Input Module on the rear panel, and the Low Frequency Input fuse (J2F1) located in the front panel INPUT 2 connector. For instructions on how to change the primary power fuse, refer to Section II, paragraph 2-8, Line Voltage Selection, and *Figure 2-1*.

CAUTION

Make sure that only fuses with the required rated current and voltage ratings and of the time delay (slow-blow) type are used for replacement of the primary power fuse. Do not use repaired fuses or short-circuited fuse holders.

3-136. The low frequency input fuse J2F1 is a 1/8A fuse (HP Part Number 2110-0301) located within the INPUT 2 BNC connector J2 (HP Part Number 1250-1899), as shown in *Figure 3-4*. To replace the fuse, disconnect the power cord, unscrew the BNC barrel and, with needle-nose pliers, remove and replace the fuse. Reinstall the BNC barrel, and tighten using a 7/16 inch wrench. Tighten to 20 inch-pounds.

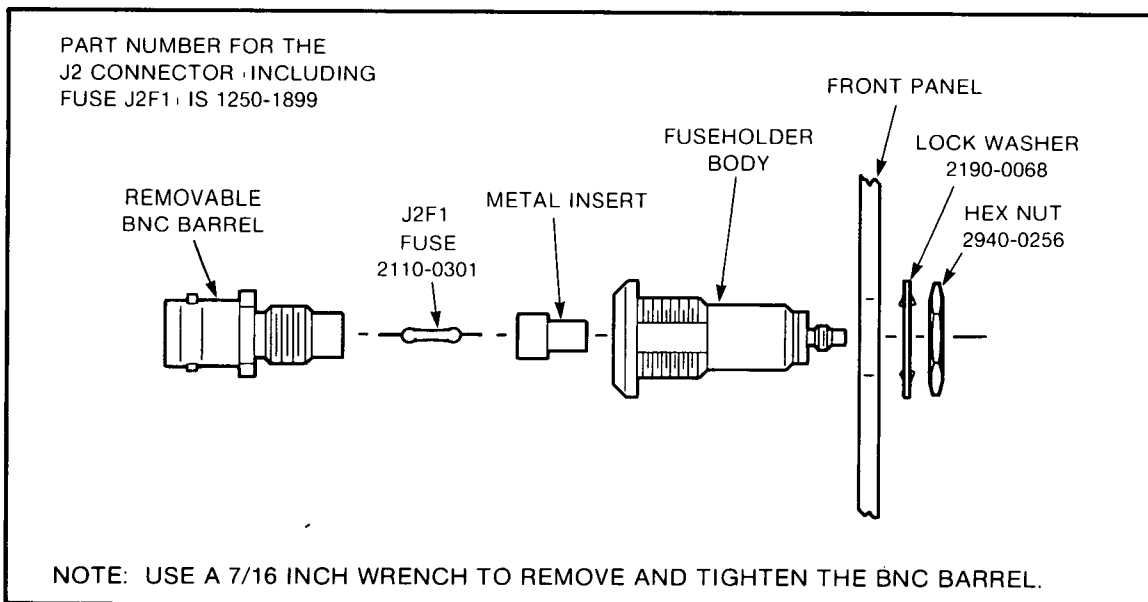

Figure 3-4. Details of INPUT 2 BNC Connector J2 and Fuse J2F1 Mounting

3-137. POWER-UP/WARM-UP

3-138. The HP 5350A/51A/52A requires a power source of 100-, 115/120-volts ac rms, +5%, -10%, 47.5-440 Hz single phase, or 220-, 230/240-volts ac rms, +5%, -10%, 47.5-66 Hz single-phase; 100 VA maximum. The selection of the line voltage and input power fuse is described in Section II, paragraph 2-5, Preparation For Use. Safety considerations are described in Section I, paragraph 1-8.

CAUTION

To prevent damage to the instrument, make sure that the voltage selector card is set to the voltage of the power source, and that the correct fuse is installed, before connecting the instrument to ac power lines. Refer to paragraph 2-8.

3-139. The HP 5350A/51A/52A has a two position (STBY/ON) power switch. For the Option 001 Oven Oscillator Timebase or the Option 010 High Stability Timebase, it is important that the instrument remain connected to the power source in the Standby (STBY) mode when not in use. This supplies power to the crystal oscillator oven, maintaining a constant oven temperature, thus eliminating the need for a warm-up period. When the Standby mode is not used, and power is disconnected from the instrument, allow 30 minutes from the application of external power in the ON mode for the instrument (crystal oven) to warm-up.

WARNING

BEFORE APPLYING AC POWER, THE INSTRUMENT AND ALL PROTECTIVE EARTH TERMINALS, EXTENSION CORDS, AUTO-TRANSFORMERS, AND DEVICES CONNECTED TO THE INSTRUMENT SHOULD BE CONNECTED TO A PROTECTIVE EARTH GROUNDED SOCKET. ANY INTERRUPTION OF THE PROTECTIVE EARTH GROUNDING WILL CAUSE A POTENTIAL SHOCK HAZARD THAT COULD RESULT IN PERSONAL INJURY.

3-140. OPERATOR'S CHECKS

3-141. The following procedures will verify the basic operation of the HP 5350A/51A/52A. These tests are not intended to verify the overall accuracy or performance specifications of the instrument. They should, however, provide the operator with a quick method of determining that the counter is operating properly. Two operator tests are described below: a Power-Up Self Test, and a Keyboard Check. The operator should perform both tests.

CAUTION

Before switching on the instrument, ensure the following:

- 1. The voltage selector card is set to match the available line voltage. (Refer to paragraph 3-118.)**
- 2. The correct fuse is installed. (Refer to paragraph 3-134.)**
- 3. All safety precautions and WARNINGS have been observed. (Refer to Safety Considerations located just after the Table of Contents, and safety precautions and WARNINGS in Sections I and II.)**

3-142. Power-Up Self Test

3-143. To perform the Power-Up Self Test after the instrument has been turned on, cycle the POWER switch to STBY (Standby), then back to ON. During the Power-Up Self Test, all front panel LCD display segments and annunciators will light momentarily, followed by the momentary display of the current HP-IB address. When all tests have been successfully completed, the counter measurement status will be restored to the conditions that were set before the POWER switch was cycled. (Note that the Power-Up Self Test is a more extensive test of the instrument than that carried out when the front panel SELF CHECK key is pressed. Refer to the diagnostic descriptions in Section VIII, Service, for details.)

3-144. If ac power was applied to the instrument just prior to turning it on, the counter will initialize itself to the following conditions when the POWER switch is set to ON:

- a. Measurement modes —
 - Auto: ON
 - Manual: OFF
 - Manual CF: 1 GHz
 - Low Frequency 50 Ω : OFF
 - Low Frequency 1M Ω : OFF
- b. Measurement modifiers —
 - Sample Rate: FAST
 - Resolution: 1 Hz
 - FM Rate Tolerance: NORMAL
 - High Resolution: OFF
- c. Math functions —
 - Offset: OFF, 0 Hz
 - Scale: OFF, 1.000
 - Smooth: OFF
- d. HP-IB address — Rear panel switch setting
- e. Diagnostics — OFF, 1

3-145. After the counter has initialized itself, the AUTO and FM NORM annunciators will be on, and the counter will begin to count, if an input has been applied to INPUT 1. If no input has been applied to INPUT 1, the display will show all zeroes, as follows:

GHz	MHz	kHz	Hz
00	000	000	000

3-146. Keyboard Check

3-147. Press the following key sequence: SET/ENTER, DIAGNOSTICS, 7, 0, SET/ENTER. The instrument will now be in the Keyboard Test diagnostic mode (Diag 70). The following message will be displayed:

KEY TEST A7 0 70

3-148. In the Keyboard Test mode, pressing the front panel keys will cause the display to change in response to the particular key being pressed. The new display will then remain until another key is pressed. For example, pressing the TRIGGER key will cause the display to change to the following:

KEY TRIGGER A7 0 70

3-149. When performing the Keyboard Test, the keys may be pressed in any order, except the RESET/LOCAL key. The operator should press each of the keys and make sure that the associated message for each key is displayed, as listed below:

OFFSET	RESOL	HP-IB	50 OHM
SCALE	SELF CK	HI RES	1M OHM
SMOOTH	DIAG	FM RATE	AUTO
SET	SAMP RT	TRIGGER	MANUAL
RESET			

3-150. Pressing the RESET/LOCAL key will cause the instrument to display "RESET" momentarily, and then exit from the test.

3-151. Power-Up Failures

3-152. A number of failure messages are possible during the Power-Up Self Test sequence. Almost all of the messages will be in a form similar to the one shown below:

FAIL 0** A2 0 20

— In this example, Diagnostic 20 (Low Frequency Input, 50Ω Verification: 35 MHz) has failed, indicating a possible problem in the A2 Low Frequency Input Assembly.

3-153. If any test during the Power-Up sequence fails, the "FAIL" message will remain until the user presses the RESET/LOCAL key. At that point, the next test is executed (if possible). By pressing the RESET/LOCAL key, most failures can be bypassed to allow the counter to proceed with the Power-Up test sequence. When the last test is complete, the counter will proceed to the normal operation mode, if possible.

3-154. Refer to Section VIII, Service, for troubleshooting information if a "FAIL" message appears during the Power-Up sequence.

3-155. Error Messages

3-156. Under certain conditions, the counter will display a message indicating that an internal error condition exists during normal instrument operation. These errors are detected by the counter and identified by one of the four numbered Error Messages listed in *Table 3-5*.

Table 3-5. HP 5350A/51A/52A Error Messages

Error 1	HP-IB interface not installed
Error 2	Internal HP-IB interface error
Error 3	Input number out of range
Error 4	HP-IB command syntax error

3-157. Error Display Examples

ERROR 1: HP-IB NOT IN 1 ERROR

ERROR 2: I/O 2 ERROR

ERROR 3: OUT OF RANGE 3 ERROR

ERROR 4: SYNTAX 4 ERROR

3-158. Numbered errors may be cleared by pressing the front panel RESET/LOCAL key, switching the counter to STBY then back to ON, or over the HP-IB using the device dependent commands "RESET", "CLR", or "INIT", or the device independent commands "DCL" or "SDC".

3-159. Overflow Warning

3-160. If an entered offset or scale value combined with the input frequency causes an overflow in the microprocessor's calculated results, the counter will display:

MATH OVERFLOW

3-161. An "OVERFLOW" warning is cleared by removing the cause: changing the offset or scale value, or lowering the input frequency.

3-162. OPERATING PROCEDURES

3-163. Introduction

3-164. The following paragraphs provide detailed operating information and instructional procedures for each major functional mode of the HP 5350A/51A/52A. Within each specific measurement mode, a considerable amount of flexibility is present for both the type of input signal and measurement technique. These operating guidelines should assist in making the most useful and accurate measurements possible.

3-165. For further information on operating the HP 5350A/51A/52A, refer to the following paragraphs in this section:

- a. Overall description of the performance capabilities and functions of the HP 5350A/51A/52A, paragraph 3-4, Operating Characteristics.
- b. Detailed description of the operation and function of each front panel key, and of the front panel display and annunciators, paragraph 3-64, Front Panel Features.
- c. Detailed description of the operation and function of each rear panel control and connector, paragraph 3-116, Rear Panel Features.

3-166. The operating procedures have been organized into the following categories for ease of reference:

- a. Measurement Modes, paragraph 3-175.
- b. Measurement Modifiers, paragraph 3-183.
- c. Math Functions, paragraph 3-192.
- d. HP-IB, paragraph 3-200.
- e. Diagnostic Functions (including Auxiliary Functions), paragraph 3-204.

3-167. Each operating procedure shows the key (or key sequence, as necessary) to be pressed to perform the desired function, and the resultant display. A brief description of the effect of each function is given, and the allowable range for any parameter values are described, if applicable. The Power-up default conditions for each function are also given, with the term "Power-up" referring to connecting ac power to the instrument and then turning it on, as distinct from "Standby", which assumes that ac power is continuously connected.

3-168. If the POWER switch is turned from ON to STBY, and then back to ON, the counter will retain the setup conditions which were active before the POWER switch was toggled. The only exceptions to this are the HP-IB interface, which is cleared, and the diagnostic mode, which will default to its power-up conditions: DIAG 1, OFF. Refer to *Table 3-2* for a list of all Power-up default and Standby conditions.

3-169. Most of the procedures include an example of a typical display for the operation being described. Some multi-key procedures show examples of displays that will occur at certain points in the indicated key sequence. The actual contents of each function display will depend on the function in progress, and on the frequency being measured.

3-170. The HP 5350A/51A/52A has four basic measurement modes:

- Automatic (INPUT 1, 500 MHz-MAX GHz)
- Manual (INPUT 1, 500 MHz-MAX GHz)
- Low Frequency 50 Ω (INPUT 2, 10 MHz-525 MHz)
- Low Frequency 1M Ω (INPUT 2, 10 Hz-80 MHz)

NOTE

- MAX = 20 GHz (5350A)
- = 26.5 GHz (5351A)
- = 40 GHz (5352A)

3-171. When first powered-up, the instrument comes on in the Auto mode. If the counter is turned on from Standby, the measurement mode will be whatever was previously set. To change to any other measurement mode, press the corresponding key. Pressing the key for the currently selected mode will have no effect.

3-172. Using certain functions, such as Offset or Scale, may involve the entry of numeric data using the Function/Data keys. Other functions allow selection of their parameter values from a specific range using the INC (increment) and DEC (decrement) keys, such as Sample Rate and Resolution. Still other functions simply toggle, such as the Smooth and FM Rate Tolerance functions. If the user should attempt to enter the incorrect type of data as a function parameter value, the counter will display one of the following messages to indicate the type of data entry required:

PLEASE USE ARROW KEYS

or:

PLEASE USE DIGIT KEYS

3-173. If data entry is attempted for a toggle function, the counter will display:

TOGGLE FUNCTION ONLY

OPERATING PROCEDURES

3-174. PRELIMINARY PROCEDURES

1. On rear panel:
 - a. Check to see that the ac power module has the proper fuse installed: 1.0A time delay (slow-blow) for 100/120-volt operation, 0.5A time-delay (slow-blow) for 220/240- volt operation. Check that the position of the pc line voltage selector card is set for the correct voltage. (Refer to paragraph 2-5, Preparation for Use, and to associated warnings and cautions in Section II of this manual for detailed instructions.)
 - b. For remote operation, refer to paragraph 3-225 for an explanation of HP-IB programming, and *Table 3-8* for information on setting the HP-IB address switch on the rear panel.
 - c. Insert the three-conductor power cable (W1) into the ac power module of the HP 5350A/51A/52A, and insert the mains plug of the power cable into a power outlet equipped with a protective earth ground.
2. On front panel:
 - a. With the POWER switch set to STBY, the red LED next to the POWER switch should light when ac power is applied.
 - b. Set the POWER switch to ON; the red LED should go out.

CAUTION

Do not exceed +25 dBm (peak) of input power at the INPUT 1 connector (500 MHz-MAX GHz). Damage to the internal sampler may occur.

An overload indication may appear on the front panel display under high input signal conditions. A power meter or similar device must be used to ensure that the input signal level does not exceed INPUT 1 specifications. DO NOT DEPEND ON THE OVERLOAD INDICATION FOR THIS PURPOSE.

CAUTION

The INPUT 2 BNC connector (10 Hz-525 MHz) is fuse-protected from input levels which exceed the specified damage level of 5.5V rms (+28 dBm).

3. Connect input signal to the appropriate input connector according to the frequency requirements (INPUT 1 N-type connector for 500 MHz-20 GHz [APC 3.5 connector for 500 MHz-26.5 GHz and 500 MHz-40 GHz], INPUT 2 BNC-type connector for 10 Hz-525 MHz.)
 4. For input signals connected to the INPUT 2 (BNC) connector, press the 50 Ω or the 1M Ω front panel key as required. Pressing one of the INPUT 2 keys disables the INPUT 1 circuitry.
 5. Refer to the following paragraphs for details on setting the sample rate, resolution, and other measurement modifiers and functions.
-

OPERATING PROCEDURES

3-175. MEASUREMENT MODES

3-176. Power-up Default Values:

Auto	- ON
Manual	- OFF
Manual CF	- 1 GHz
Low Frequency, 50 Ω	- OFF
Low Frequency, 1M Ω	- OFF

3-177. Automatic Measurement Mode (AUTO):

Example: Automatic measurement of 1.000 000 000 GHz.

Press:  | GHz | MHz | kHz | Hz |
| 1 | 000 | 000 | 000

(AUTO annunciator goes on)

Effect: Turns ON Automatic Measurement Mode (INPUT 1, 500 MHz-MAX GHz). To exit this mode, press one of the other measurement mode keys; pressing the AUTO key a second time has no effect. The instrument powers-up in this mode.

Parameter Value Range: ON function only.

3-178. Manual Measurement Mode (MANUAL):

Example: Turn on Manual Mode, Manual CF set to last Auto measurement of 1.200 000 000 GHz.

Press:  | GHz | MHz | kHz | Hz |
| 1 | 200 | 000 | 000 | MANUAL

(displays new CF momentarily, then returns to measurement display; MAN annunciator goes on)

Effect: Turns ON Manual Measurement Mode (INPUT 1, 500 MHz-MAX GHz), and sets Manual Center Frequency (CF) to value of last Auto measurement. To exit this mode, press one of the other measurement mode keys; pressing the MANUAL key a second time has no effect.

Parameter Value Range: Last Auto measurement value must be within 500 MHz-33 GHz [500 MHz-43 GHz, 5352A]. If last Auto measurement is invalid, the Manual CF remains at the previous setting.

OPERATING PROCEDURES

3-179. Set Manual Center Frequency:

Example: Set Manual CF to 12.3 GHz.

Press: SET / ENTER MANUAL **1** **2** **3** **0** **0**

GHz	MHz	kHz	Hz	MANUAL
12	300			MANUAL

Press: SET / ENTER

GHz	MHz	kHz	Hz	MANUAL
12	300	000	000	MANUAL

(displays new CF momentarily, then returns to measurement display; MAN annunciator goes on)

Effect: Sets Manual Center Frequency, turns ON Manual Measurement Mode (INPUT 1, 500 MHz-MAX GHz). Instrument begins to count using new Center Frequency. To exit this mode, press one of the other measurement mode keys.

Parameter Value Range: 500 MHz-33 GHz | 500 MHz-43 GHz, 5352A]. If no Manual CF value is entered, the CF remains the last entered value, or defaults to 1 GHz. The CF must be no more than 20 MHz from the frequency to be measured (within 3 MHz for frequencies below 1 GHz).

3-180. Set Manual Center Frequency to Last Measured Frequency:

Example: Set Manual CF to last measured frequency of 850 MHz.

Press: SET / ENTER MANUAL **+** **LST** **FRQ**

GHz	MHz	kHz	Hz	MANUAL
850	000	000	000	MANUAL

Press: SET / ENTER (new CF entered, counter begins manual measurement)

Effect: Sets Manual CF to value of last measurement, and turns ON Manual Measurement Mode (INPUT 1, 500 MHz-MAX GHz). Instrument begins to count using new Center Frequency. To exit this mode, press one of the other measurement mode keys.

Parameter Value Range: Last measurement value must be within 500 MHz-33 GHz | 500 MHz-43 GHz, 5352A]. If last measurement is invalid, the Manual CF will remain at the previous setting.

OPERATING PROCEDURES

3-181. Low Frequency, 50 Ω Measurement Mode:

Example: Measure 325.000 000 MHz.



(50 Ω annunciator goes on)

Effect: Turns ON Low Frequency, 50 Ω Measurement Mode (INPUT 2, 10 MHz-525 MHz). To exit this mode, press one of the other measurement mode keys; pressing the 50 Ω key a second time has no effect.

Parameter Value Range: ON function only.

3-182. Low Frequency, 1M Ω Measurement Mode:

Example: Measure 50.000 kHz.

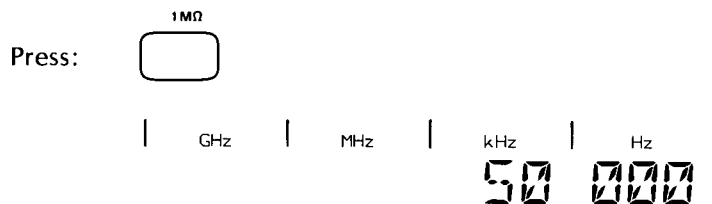

(1M Ω annunciator goes on)

Effect: Turns ON Low Frequency, 1M Ω measurement Mode (INPUT 2, 10 Hz-80 MHz). To exit this mode, press one of the other measurement mode keys; pressing the 1M Ω key a second time has no effect.

Parameter Value Range: ON function only.

OPERATING PROCEDURES

3-183. MEASUREMENT MODIFIERS

3-184. Power-up Default Values:

Resolution	- 1 Hz
High Resolution	- OFF
Sample Rate	- FAST
Trigger	- Not Applicable
FM Rate Tolerance	- NORMAL

3-185. Resolution:

Example: Display current resolution of 10 kHz, for measurement of 50.00 MHz.

Press: ◀ RESOLUTION ▶

	GHz		MHz		kHz		Hz	
	00		000		01*		***	
								RESOL

(displays current resolution)

	GHz		MHz		kHz		Hz	
			50		00*			

(measurement at 10 kHz resolution)

Effect: Displays current resolution setting as long as RESOLUTION key is held down.

Parameter value range: Display function.

Note: When a group of three digits in the display is suppressed due to the resolution setting, all three digits are blanked. If only one or two digits in a three digit group are suppressed, the suppressed digits are replaced with asterisks * .

OPERATING PROCEDURES

3-186. Set Resolution:

Example: Change resolution from 1 Hz to 1 MHz. Counter is assumed to be measuring 1.234567890 GHz.

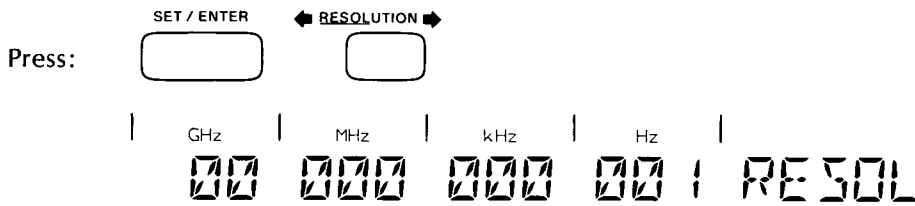

(displays current resolution setting)

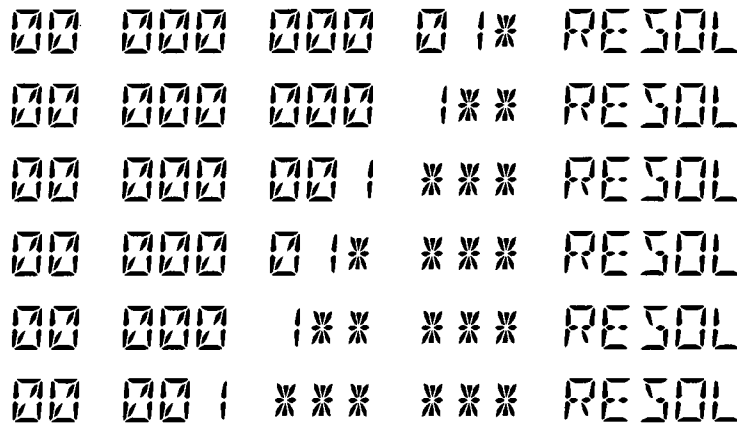
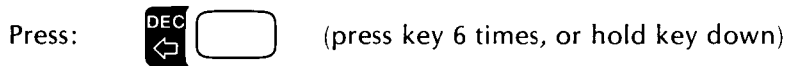

(begins counting with 1 MHz resolution)

Effect: Sets the resolution for INPUT 1 or INPUT 2 measurements.

Parameter Value Range: 1 Hz to 1 MHz, in decade steps.

OPERATING PROCEDURES

3-187. High Resolution:

Example: Turn on High Resolution while making a 1MΩ (INPUT 2) measurement of 5 000 000.000 Hz, then turn High Resolution off.

Press:

HIGH RESOL ON

(displays message momentarily; HIGH RESOL annunciator goes on)

GHz	MHz	kHz	Hz
	5	000	000.0***

(measurement with High Resolution in effect)

Press:

HIGH RESOL OFF

(displays message momentarily; HIGH RESOL annunciator goes off)

Effect: Turns High Resolution function ON and OFF. Displays “HIGH RESOL ON” (or off) message as long as HIGH RESOL key is held down. The high resolution measurement begins (or stops) as soon as the key is released.

Parameter Value Range: Toggle function only.

Note: The High Resolution function can only be applied to INPUT 2, 1MΩ impedance measurements (10 Hz-80 MHz), in which case it takes precedence over the current resolution setting. The Smooth function takes precedence over the High Resolution function.

The higher resolution obtained using this function depends on the input frequency, as shown in Table 3-6 (where F_{in} = input frequency to INPUT 2).

Table 3-6. High Resolution Displays

Frequency Range	Resolution	Display Example								
$80 \text{ MHz} \geq F_{in} \geq 10 \text{ MHz}$	1 Hz	<table border="1"> <tr> <td>GHz</td> <td>MHz</td> <td>kHz</td> <td>Hz</td> </tr> <tr> <td></td> <td>15</td> <td>000</td> <td>000</td> </tr> </table>	GHz	MHz	kHz	Hz		15	000	000
GHz	MHz	kHz	Hz							
	15	000	000							
$10 \text{ MHz} > F_{in} \geq 1 \text{ MHz}$	0.1 Hz	<table border="1"> <tr> <td>GHz</td> <td>MHz</td> <td>kHz</td> <td>Hz</td> </tr> <tr> <td></td> <td>1</td> <td>500</td> <td>000.0***</td> </tr> </table>	GHz	MHz	kHz	Hz		1	500	000.0***
GHz	MHz	kHz	Hz							
	1	500	000.0***							
$1 \text{ MHz} > F_{in} \geq 0.1 \text{ MHz}$	0.01 Hz	<table border="1"> <tr> <td>GHz</td> <td>MHz</td> <td>kHz</td> <td>Hz</td> </tr> <tr> <td></td> <td>150</td> <td>000</td> <td>00.0***</td> </tr> </table>	GHz	MHz	kHz	Hz		150	000	00.0***
GHz	MHz	kHz	Hz							
	150	000	00.0***							
$0.1 \text{ MHz} > F_{in} \geq 10 \text{ Hz}$	0.001 Hz	<table border="1"> <tr> <td>GHz</td> <td>MHz</td> <td>kHz</td> <td>Hz</td> </tr> <tr> <td></td> <td>15</td> <td>000</td> <td>000</td> </tr> </table>	GHz	MHz	kHz	Hz		15	000	000
GHz	MHz	kHz	Hz							
	15	000	000							

OPERATING PROCEDURES

3-188. Sample Rate:

Example: Display sample rate setting of 1.0 seconds.

Press: 

HOLD-----*---FAST SMPL RT

Effect: Display current sample rate setting as long as SAMPLE RATE key is held down.

Parameter Value Range: Display function.

Note: The Sample Rate function sets the dead time between measurements. Total measurement time, or repetition rate, is affected by the measurement mode and other functions, as well as the input frequency.

OPERATING PROCEDURES

3-189. Set Sample Rate:

Example: Change sample rate from FAST to HOLD.

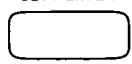
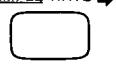
Press:  
 HOLD FAST SMP L RT
 (displays current sample rate)

Press:  (press key 7 times, or hold key down)
 HOLD * .. FAST SMP L RT
 (0.5 sec.)
 HOLD * .. FAST SMP L RT
 (1.0 sec.)
 HOLD * .. FAST SMP L RT
 (1.5 sec.)
 HOLD * .. FAST SMP L RT
 (3.0 sec.)
 HOLD .. * .. FAST SMP L RT
 (5.0 sec.)
 HOLD * .. FAST SMP L RT
 (10.0 sec.)
 HOLD < .. FAST SMP L RT
 (HOLD annunciator goes on)

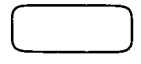
Press: 
 HOLDING ..
 (no measurement until triggered)

Effect: Sets sample rate for INPUT 1 and INPUT 2 measurements.

Parameter Value Range: Fast, 0.5 seconds, 1.0 seconds, 1.5 seconds, 3.0 seconds, 5.0 seconds, 10.0 seconds, Hold.

OPERATING PROCEDURES

3-190. Trigger:

Example: Trigger and hold a measurement of 25.000 000 MHz.

HOLDING-----

(sample rate set to "HOLD", first measurement not yet triggered)

Press:

| GHz | MHz | kHz | Hz |

25 000 000

(measurement taken and held, "HOLD" annunciator remains on)

Effect: If sample rate is set to Hold, triggers a measurement.

Parameter Value Range: None.

3-191. Set FM Rate Tolerance:

Press:

LOW FM RATE

(displays message momentarily, then returns to measurement display;
FM LOW annunciator on, FM NORM annunciator off)

Press:

NORMAL FM RATE

(displays message momentarily, then returns to measurement display;
FM NORM annunciator on, FM LOW annunciator off)

Effect: Sets FM Rate Tolerance to Low FM rate (if normal), or Normal FM rate (if low).

Parameter Value Range: Toggle function only.

Note: This function applies only to measurements in Auto mode (INPUT 1, 500 MHz-MAX GHz).

OPERATING PROCEDURES

3-192. MATH FUNCTIONS

3-193. Power-up Default Values:

Offset - OFF, 0 Hz
Scale - OFF, 1.000
Smooth - OFF

3-194. Offset:

Example: Turn on Offset function to apply current offset value of -50 MHz to measurement of 200 MHz.

Press: 

| GHz | | MHz | | kHz | | Hz |
--50 000 000 OFFSET

(displays current offset momentarily; OFFSET annunciator goes on)

| GHz | | MHz | | kHz | | Hz |
150 000 000

(200 MHz measurement with -50 MHz offset applied)

Effect: Turns Offset function ON and OFF. When turned ON, current offset is displayed. When key is released, display shows the sum of the current measurement plus the offset. Press the key a second time to turn the Offset function back to OFF.

Parameter Value Range: Toggle function.

OPERATING PROCEDURES

3-195. Set Offset Frequency

Example: Change offset value from 1.619 GHz to -35.5 MHz, and apply offset to 600 MHz measurement.

Press:

GHz	MHz	kHz	Hz	
1	619.	000	000	OFFSET

(displays current offset value)

Press:

GHz	MHz	kHz	Hz	
	--35.	5		OFFSET

Press:

GHz	MHz	kHz	Hz	
	--35.	500	000	OFFSET

(displays new offset momentarily,
then measurement begins with offset applied;
OFFSET annunciator goes on)

GHz	MHz	kHz	Hz
	564.	500	000

(600 MHz measurement with -35.5 MHz offset applied)

Effect: Sets Offset value, and turns ON the Offset function. To turn OFF the Offset function, press the OFFSET key again.

Parameter Value Range: 0 Hz to ± 999.999999999 GHz.

Note: When entering an offset value, the sign may be changed at any point in the key sequence using the sign (\pm) key.

OPERATING PROCEDURES

3-196. Set Offset Value to Last Frequency:

Example: Change offset from current value of -35.5 MHz to negated last measurement value of 200.000 000 MHz.

Press:

GHz	MHz	kHz	Hz
--35	500	000	OFFSET

(displays current offset)

Press:

GHz	MHz	kHz	Hz
--200	000	000	OFFSET

(displays negated value of last measurement)

Press:

GHz	MHz	kHz	Hz
			0

(displays measurement with offset applied; OFFSET annunciator goes on)

Effect: Sets Offset value to last measured frequency, and turns ON the Offset function. To turn OFF the Offset function, press the OFFSET key again.

Parameter Value Range: Last measured frequency must be within 0 Hz to ± 999.999999999 GHz.

OPERATING PROCEDURES

3-197. Scale:

Example: Apply current scale factor of 1.5 to 600 MHz measurement.

Press: 

| GHz | MHz | kHz | Hz |

1500 SCALE

(displays current scale factor)

| GHz | MHz | kHz | Hz |

900 000 000

(measurement with scale factor applied; SCALE annunciator goes on)

Effect: Turns Scale function ON and OFF. When turned ON, current scale factor is displayed. When key is released, display shows product of the current input signal measurement multiplied by the scale factor.

Parameter Value Range: Toggle function.

OPERATING PROCEDURE

3-198. Set Scale Value:

Example: Change scale from 1.5 to -0.001 for 600 MHz measurement.

Press: SET / ENTER . 0 0 1 ±

| GHz | MHz | kHz | Hz |

--0.001 SCALE

Press: SET / ENTER

| GHz | MHz | kHz | Hz |

--600 000

(measurement with scale factor applied; SCALE annunciator goes on)

Effect: Sets scale value, and turns ON the Scale function. To turn the Scale function OFF, press the SCALE key again.

Parameter Value Range: ± 0.0001 to ± 9999 (except 0; if 0 is entered, scale value defaults to +1).

Note: When entering a scale factor, the sign may be changed at any point in the key sequence using the sign (\pm) key.

3-199. Smooth:

Press: SMOOTH (SMOOTH annunciator goes on)

Effect: Turns Smooth function ON or OFF. Input frequency is averaged, and unstable digits in the display are masked with asterisks or with blanks, similar to Resolution display.

Parameter Value Range: Toggle function only.

Note: The number of masked digits in a Smooth display will vary continuously, depending on the stability of the source. Refer to the Resolution procedure for examples of the various possible Smooth displays.

OPERATING PROCEDURES

3-200. HP-IB

3-201. Power-up Default Values:

HP-IB Address - HP-IB rear panel switch setting (A11S1)

NOTE

The rear panel switch is read only after completion of all power-up self tests. The HP-IB address will be 00 until all power-up tests are completed and HP-IB initialization has occurred.

3-202. HP-IB Address:

Example: Display current HP-IB address of 14.

HP-IB ADDRESS
Press:

14 HP-IB

Effect: Displays current HP-IB address momentarily, then returns to measurement display.

Parameter Value Range: Display function.

Note: If the current instrument address is "31", the display is:

TALK ONLY 31 HP-IB

(TALK annunciator on)

OPERATING PROCEDURES

3-203. Set HP-IB Address:

Example: Change HP-IB address from 14 to 27.

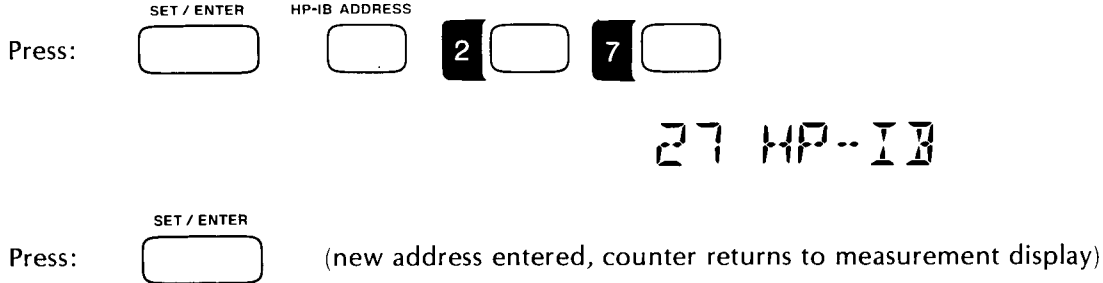

Effect: Sets HP-IB address. This address will be saved if the counter is switched to STBY. If ac power is removed from the instrument, and then reapplied, the HP-IB address will be determined by the switch settings of the rear panel HP-IB address switch (A11S1) after all power-up self tests are completed. No exit procedure is required for this mode, as the counter will automatically return to its previous status after the HP-IB address has been entered.

Parameter Value Range: 0 to 30 (31 = TALK ONLY).

Note: Be sure that the instrument address is not set to the same address as that of the controller. Typical HP controllers use address "21" as a preset address, thus the use of address "21" as the HP 5350A/51A/52A address code should be avoided.

When the HP-IB address is set to 31, the interface addresses itself to TALK, and will continuously handshake measurements over the bus. To escape the TALK ONLY mode, the user must change the address and cycle the POWER switch.

OPERATING PROCEDURES

3-204. DIAGNOSTIC FUNCTIONS

3-205. Power-up Default Values:

Diagnostics – DIAG 1, OFF

3-206. When using the diagnostic functions, many different types of messages are possible. In the following paragraphs, only PASS messages are shown. Refer to Section VIII, Service, for descriptions of the various FAIL messages.

3-207. Most diagnostic functions can be exited by pressing the DIAGNOSTICS key or the RESET/LOCAL key. However, certain diagnostics require special exit procedures, as described in paragraph 3-212.

3-208. Self Check:

Press: 

PASS 35 000 0** SELF

(displays Pass or Fail message)

Effect: Turns ON Self Check routine. If Self Check passes, the pass message will be displayed briefly, and then the counter returns automatically to its previous measurement mode. However, if Self Check fails, the RESET/LOCAL key must be pressed to bypass any failures, and to exit the Self Check function.

Parameter Value Range: None.

3-209. Diagnostics:

Example: Turn ON current Diagnostic function (Diag 20 Low Frequency 50Ω Verification: 35 MHz).

Press: 

PASS 35 000 0** A2 0 20

(displays Pass or Fail message)

Effect: Turns current diagnostic function ON or OFF.





Parameter Value Range: Toggle function.

Note: Diag 97 (IF 175 MHz Filter Adjust), Diag 98 (Keyboard Lockout), and Diag 99 (Display Lockout) cannot be entered by pressing the DIAGNOSTICS key. The diagnostic number is not retained by the counter after one of these diagnostics has been exited; instead, the diagnostic number automatically defaults to 1.

OPERATING PROCEDURES

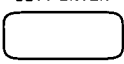
3-210. Set Diagnostic Number:

Example: Change Diagnostic number from 1 (Self Test) to 60 (IF Verification: 35 MHz; Disable INPUT 1 and IF), and turn Diagnostic function ON.

Press:    

60 IFAG

Press: 

PASS 35 000 0** AG 1 60





(displays Pass or Fail message)

Effect: Sets diagnostic test number and turns ON diagnostic mode.

Parameter Value Range: 1 to 99. If an invalid diagnostic number is entered, the counter will display a "NOT AVAILABLE" message.

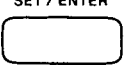
3-211. Move to Next Diagnostic:

Example: Change Diagnostic number from 30 (MRC Channel A Verification; 10 MHz Timebase) to 32 (Interpolator Check).

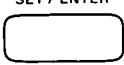
Press:     

PASS INTERPOL AG 1 32

(Counter displays Pass or Fail message)

Effect: Sets diagnostic function number to next higher or lower number, and proceeds to execute that test.

Parameter Value Range: 1 to 96. If the user increments or decrements to an invalid diagnostic number, the counter will display a "NOT AVAILABLE" message until the user has moved to a valid number. (Note that Diag 97, Diag 98, and Diag 99 cannot be enabled using the arrow keys.)

OPERATING PROCEDURES

3-212. Special Diagnostic Exit Procedures

3-213. Most diagnostic functions can be exited by pressing the DIAGNOSTICS key or the RESET/LOCAL key. Some diagnostics require special exit procedures, as follows:

- a. To exit from a Diag 1 failure, press the DIAGNOSTICS key; pressing the RESET/LOCAL key will only scroll through the tests.
- b. To exit Diag 51 (LO Synthesizer Verification – User-Entered Frequency) or Diag 70 (Keyboard Test), press the RESET/LOCAL key; the DIAGNOSTICS, INCREMENT, and DECREMENT keys cannot be used to exit.
- c. The only way to exit from Diag 97 (IF 175 MHz Filter Adjust) is to switch the counter to STBY. When the counter is powered-up again, the Diagnostic number defaults to 1.
- d. The only way to exit Diag 98 (Keyboard Lockout), and Diag 99 (Display Lockout) is by entering a special key sequence (7, 4, 0, RESET/LOCAL), or by removing ac power to the instrument. After exiting Diag 98 or 99, the diagnostic number defaults to 1.
- e. When pressing the special key sequence to exit Diag 98 or 99, the operator should allow a short amount of time (about 1 to 2 seconds) to elapse between each key press. Pressing the keys too quickly prevents the counter from responding properly to each key in the sequence, causing the counter to remain in the diagnostic mode.

3-214. AUXILIARY FUNCTIONS

3-215. Eight of the front panel diagnostics, Diag 2 through 9, are referred to as auxiliary functions. When an auxiliary function is activated, the counter continues to carry out a normal measurement cycle, but does not display the measured input frequency. Instead, each auxiliary function causes the counter to display a particular measurement parameter used to compute the measured input frequency. The following paragraphs contain brief descriptions of the auxiliary functions. Unless otherwise noted, a given auxiliary function will display a measurement parameter for either an INPUT 1 or INPUT 2 measurement.

3-216. The auxiliary functions are selected using the Diagnostic Function operating procedures beginning at paragraph 3-209. When the counter is in the auxiliary function mode, it does not display a pass or fail message, but displays only the measurement parameter. The contents of each auxiliary function display depend on the particular parameter involved. During any auxiliary function display, an overload condition, if present, will be indicated by the letters "OVLD" replacing a portion of the display. Refer to Section VIII, Service, for detailed descriptions of all diagnostics, including auxiliary functions, and for information on the various measurement parameters displayed.

3-217. Display IF

Diag 2: IF 50 000 130 .49 0 02

Effect: The counter will display the value of the IF, showing one digit greater than the chosen resolution (two digits for 1 Hz). The chosen resolution and sample rate will affect the display, and also the Smooth function, if enabled. The IF will be displayed only when the counter is set to INPUT 1; when set to INPUT 2, the counter will display the low frequency measurement.

3-218. Display MRC E & T Register Contents

Diag 3: E 100 197 13 T 200393728

Effect: The counter will display the contents of the MRC Events (E) and Time (T) registers, including overflow. The chosen resolution will affect the contents of the Time register (gate time), but the selected sample rate will not affect register contents. Math functions, if enabled, also have no effect. The T register portion of the display includes the fraction (in decimal form) calculated from the interpolator data.

3-219. Display LO (Synthesizer) Frequency

Diag 4: LO 3500 MHZ DIAG 04

Effect: Displays the current value of the LO frequency. In Auto mode, the LO value is displayed only when a measurement is in progress, not during signal acquisition or LO sweep. In Manual mode, the display of the LO value will be stable. If the counter is switched to INPUT 2, the last LO value from either of the INPUT 1 modes (Auto or Manual) will appear.

3-220. Display Harmonic Number (integer) and Sideband

Diag 5: HARM 3 LSB DIAG 05

Effect: Displays the value of the harmonic number (N), along with the sideband location of the input frequency (USB = upper sideband, LSB = lower sideband) with respect to $N \cdot LO$. If the instrument is in Auto or Manual mode, the display will only change when a new harmonic number has been determined. In INPUT 2, the harmonic number will be 0, and "USB" will be displayed.

3-221. Display Harmonic Number (fraction) and Sideband

Diag 6: HARM 2.99 LSB DIAG 06

Effect: Displays the value of the harmonic number (N) to .01 accuracy, along with the sideband information (refer to Diag 5 description). When the counter is in Manual mode, the fractional value of N will be the same as the integer value. This auxiliary function can be used to see if FM on the input signal is affecting the measurement.

3-222. Display Interpolator Short Calibration

Diag 7: SH CAL 126 125 DIAG 07

Effect: The Interpolator Start and Stop counts are displayed for the short MRC calibration mode. The Start and Stop values should be within ± 20 counts of each other, with a typical calibration count falling in the approximate range of 100-130. The Short calibration values should always be less than the values displayed by Diag 8 (Interpolator Long Calibration).

3-223. Display Interpolator Long Calibration

Diag 8: LONG CAL 308 307 DIAG 08

Effect: The Interpolator Start and Stop counts are displayed for the long MRC calibration mode. The Start and Stop values should be within ± 20 counts of each other, with a typical calibration count falling in the approximate range of 290-310. The long calibration values should always be greater than the values displayed by Diag 7 (Interpolator Short Calibration).

3-224. Display Interpolator Measurement

Diag 9: MEAS 245 2 18 DIAG 09

Effect: The Interpolator Start and Stop counts are displayed for the current measurement. The Start value (the three digits to the left) should fall within the range of the Start values displayed by the Short Calibration (Diag 7) and Long Calibration (Diag 8) functions described above. Similarly, the Stop value (the three digits to the right) should fall within the range of the Stop values displayed by Diag 7 and Diag 8.



3-225. REMOTE PROGRAMMING VIA THE HP-IB.

3-226. Introduction

3-227. The HP 5350A/51A/52A Microwave Frequency Counter is compatible with the Hewlett-Packard Interface Bus (HP-IB). The HP-IB interface is installed as standard equipment and allows the instrument to respond to remote control instructions and output measurement data via the HP-IB. At the simplest level, the HP 5350A/51A/52A can output data in the "talk only" mode to another device, such as a printer. In more sophisticated systems, a computing controller can remotely program the counter to perform a specific type of measurement, trigger the measurement, and collect the results.

NOTE

HP-IB is Hewlett-Packard's implementation of IEEE Std. 488-1978, "Standard Digital Interface for Programming Instrumentation".

3-228. To remotely program the counter, the operator must be familiar with the selected controller, the configured interface, and the local operation and functional capabilities of the HP 5350A/51A/52A. Typical controllers for the HP-IB are the 9825A/B, 9826A, 9835A, 9836A, 9816A, 9845A, or HP-85. The following manuals should provide useful background information:

- Hewlett-Packard 85 Owner's Manual and Programming Guide
- Hewlett-Packard 85 Advanced Programming ROM Owner's Manual
- Hewlett-Packard 9825A Operating and Programming Reference Manual
- Hewlett-Packard 9825A I/O Control Reference Manual
- Hewlett-Packard 9825B Manual Kit
- Hewlett-Packard 9826A BASIC Manual Set
- Hewlett-Packard 9835A/B Operating and Programming Manual
- Hewlett-Packard 9845A Operating and Programming Guide
- Condensed Description of the Hewlett-Packard Interface Bus
- Tutorial Description of the Hewlett-Packard Interface Bus
- Hewlett-Packard Series 200 Basic Interfacing Techniques
- HP 5350A/5351A Introductory Operating Guide

3-229. HP-IB Description

3-230. The Hewlett-Packard Interface Bus (HP-IB) is a high speed parallel interface bus. All devices on the bus are capable of being addressed at one time. However, only one device may respond at a time. The controller is used to command a specific device to respond, and maintain the flow of data and interface functions.

3-231. The HP-IB system uses a party-line structure (devices share signal lines). A maximum of 15 devices may be connected in an HP-IB system, in virtually any configuration desired. There must be an uninterrupted path to every device operating on the bus. Sixteen signal lines and eight control lines are used to interconnect devices in parallel arrangement and maintain an orderly flow of device and interface related information.



3-232. Interface System Terms

3-233. The following paragraphs define terms and concepts used to describe HP-IB system operations.

- a. Address: Each device on the interface is assigned an address. The address is used to specify which device will receive information or send information.
- b. Byte: A byte is a unit of information consisting of eight binary digits called bits.
- c. Device: Any instrument or unit that is HP-IB compatible is called a device.
- d. Device Independent Command: A command predefined by the interface standard to have a specified bit pattern and resulting action.
- e. Device Dependent Command: A command that is specific to a particular instrument or family of instruments, which is not predefined by the interface standard. Device dependent commands are usually sent as ASCII strings of characters.
- f. Polling: Polling is a process typically used by a controller to locate a device that requires service from the controller. There are two types of polling, Serial Poll and Parallel Poll:
 1. Serial Poll: When the controller executes a serial poll, the addressed device sends one byte of operational information called a status byte. If more than one device on the interface is capable of requesting service, each device on the interface must be polled until the device that requested service is located.
 2. Parallel Poll: The HP 5350A/51A/52A does not have parallel poll capability.

3-234. Major Interface Functions

3-235. Each device on the interface may have one or more of the following major device capabilities: Controller, Talker, or Listener. The controller has the responsibility of controlling interface activity, and must be equipped with the proper interface module. Controllers transmit all device independent commands to other devices in the interface and usually have Talker and Listener capabilities. Only one device on the interface may be the active controller at any one time. The HP 5350A/51A/52A Counter has no controller capabilities.

3-236. Talkers are devices that have the ability to send data or device dependent commands through the interface. Note that a talker will not actually send data or information until the appropriate command is sent by the controller. The HP 5350A/51A/52A Counter has Talker capabilities. When the counter is talking on the interface, or is addressed to talk, the TLK annunciator will turn on. In special situations, a device may be classified as a Talk Only device, and send information to Listen Only devices. Such a system has no controller. For example, the counter can be configured to TALK ONLY and send measurement results to a printer by setting the HP 5350A/51A/52A HP-IB address to 31.



3-237. Listeners are devices with capability to receive information over the interface. When the counter is listening, or addressed to listen, the LSN annunciator turns on. Listeners must also be enabled by the controller to receive data or information.

3-238. Interface Capabilities

3-239. The capabilities of a device connected to the bus are specified by its interface functions. These functions provide the means for a device to receive, process, and send messages over the bus. Table 3-7 lists the HP-IB interface functions defined by the IEEE 488-1978 standard, including the name, mnemonic, and a brief description. A subset identifier (the interface function mnemonic followed by a number) indicates the specific HP-IB interface function capabilities of a particular instrument. The specific interface capabilities of the HP 5350A/51A/52A are also listed in Table 3-7, including the complete subset identifiers.

Table 3-7. HP 5350A/5351A/5352A HP-IB Interface Function Capabilities

Name and Mnemonic	Description	Subset Identifier	Description
Source Handshake (SH)	Capability to properly translate a multiline message.	SH1	The 5350A/51A/52A can generate messages.
Acceptor Handshake (AH)	Capability to guarantee proper reception of remote multiline messages.	AH1	The 5350A/51A/52A can interpret received messages.
Talker (T)	Capability to transmit data over the bus when addressed.	T5	The 5350A/51A/52A can function as a talker. In addition, it can operate as a Talk Only instrument and will respond to serial poll. It will unlisten if addressed as a talker.
Extended Talker (TE)	Talker capability with address extension.	TE0	The 5350A/51A/52A cannot function as an extended talker.
Listener (L)	Capability to receive data over the bus when addressed.	L4	The 5350A/51A/52A can function as a listener. In addition, it will untalk if addressed as a listener.
Extended Listener (LE)	Listener capability with address extension.	LE0	The 5350A/51A/52A cannot function as an extended listener.
Service Request (SR)	Capability permitting a device to asynchronously request service from the controller.	SR1	The 5350A/51A/52A can generate a service request.



Table 3-7. HP 5350A/5351A/5352A HP-IB Interface Function Capabilities

Name and Mnemonic	Description	Subset Identifier	Description
Remote/ Local (RL)	Capability to select between two sources of input information: local (front panel controls) and remote (input information from the bus.)	RL1	The 5350A/51A/52A can operate both in remote and local modes. In addition, it can respond to local lockout.
Parallel Poll (PP)	Provides capability for a device to uniquely identify itself if it requires service and the controller is requesting a response. This capability differs from service request in that it requires a commitment of the controller to periodically conduct a parallel poll.	PP0	The 5350A/51A/52A does not support parallel poll.
Device Clear (DC)	This function allows a device to be initialized to a predefined state.	DC1	The 5350A/51A/52A supports both the Device Clear (DCL) and Selected Device Clear (SDC) commands.
Device Trigger (DT)	This function permits a device to have its basic operation initiated by the talker on the bus.	DT1	The 5350A/51A/52A can be remotely triggered.
Controller (C)	This function permits a device to send addresses, universal commands, and addressed commands to other devices on the HP-IB. It may also include the ability to conduct polling to determine devices requiring service.	C0	The 5350A/51A/52A cannot function as a controller.
Drivers (E)	This code describes type of electrical drivers used in a device.	E1	The 5350A/51A/52A uses open-collector drivers.



3-240. Nearly all controls on the counter can be programmed remotely, and data from the measurements can be sent to the controller through the HP-IB. The HP 5350A/51A/52A operates as both a talker and a listener, as described in *Table 3-7*. The counter's output format is the same regardless of the mode (Talk Only/Addressable). The following paragraphs describe the basic programming capability of the HP 5350A/51A/52A Microwave Counter.

- TALK:** The 5350A/51A/52A can be addressed to TALK by a controller or by entering the TALK ONLY address, 31. When addressed as a Talker, the counter will send data to other devices on the bus. This data may be the result of a measurement, error messages, diagnostic results, etc.
- LISTEN:** When addressed as a Listener, the instrument will accept any number of commands from a controller on the bus. These commands are used to program the instrument operation.
- SERVICE REQUEST:** SRQ will be generated on the interface when an enabled status bit is set. The 5350A/51A/52A has the capability to request service asynchronously from the controller in charge of the bus. Refer to paragraphs 3-261 and 3-268 for a description of the Service Request Mask (SRQMASK) command.
- REMOTE/LOCAL:** At power-up, the counter is under front panel (local) control. To program the 5350A/51A/52A, it must be placed in Remote. Once in Remote, programmable functions cannot be affected by the front panel controls. The RESET/LOCAL key may be used to manually return to local control only if the Local Lockout (LLO) is off. If Local Lockout is on, the RESET/LOCAL key is ignored, and the bus command LOCAL must be sent to disable LLO.
- PARALLEL POLL:** The 5350A/51A/52A does not respond to parallel poll.
- DEVICE CLEAR:** When a universal or selected device clear is received, the 5350A/51A/52A clears any errors present, clears all input and output buffers, and resets the hardware for a new measurement.
- DEVICE TRIGGER:** When a device trigger is received, the counter will start a new measurement, if the sample rate is set to HOLD. If the sample rate is not set to HOLD, the device trigger command is ignored.
- CONTROLLER:** The 5350A/51A/52A cannot be used as controller.

3-241. Front Panel Interface Status Annunciators

3-242. The remote status of the HP 5350A/51A/52A is indicated on the front panel by four Interface Status annunciators in the liquid crystal display. To indicate the Interface Status function, an arrow (→) appears at the bottom of the display just above the name of one of the four status labels on the front panel: REM, LSN, TLK, or SRQ. The REM annunciator lights to indicate the counter is under remote control. The LSN annunciator lights to indicate the counter is addressed to listen (receive commands). The TLK annunciator lights to indicate the counter is addressed to talk (send data). The SRQ annunciator lights to indicate that a service request condition exists (as determined by a set service request mask bit).



3-243. Address Selection

3-244. To use the HP 5350A/51A/52A in an HP-IB system, the counter must be set to the desired address, as described in *Table 3-8*. The ADDRESSABLE mode is used whenever a calculator or other controller is used with the system, and the HP 5350A/51A/52A functions as a talker and a listener. The TALK ONLY mode is used when the counter is operating under its own control (no controller on bus) and outputting results to another device on the bus, such as a printer. In the TALK ONLY mode, the HP 5350A/51A/52A functions only in an output condition, and the receiving device must be set to LISTEN ONLY.

3-245. The HP-IB address for the HP 5350A/51A/52A can be set in one of two ways: by front panel entry or by setting the rear panel HP-IB address switch. The address set using the rear panel switch is a default address which the counter will be set to if ac power has been removed and then restored to the instrument. If the counter has been switched to STBY (using the POWER switch), the address set by front panel keyboard entry will be retained as the HP-IB address. Refer to *Table 3-8* for all possible address settings and the corresponding ASCII codes for Talk and Listen, in the ADDRESSABLE mode and in the TALK ONLY mode.

3-246. To set or change the HP 5350A/51A/52A HP-IB Address via the front panel, refer to the front panel operating procedure for entering the HP-IB address, at paragraph 3-203.



Table 3-8. Address Selection

ADDRESS 14 SHOWN

NOTE
Select the HP-IB address from the table below and set the address.

SELECTED ADDRESS	ADDRESS SWITCHES					ASCII CHARACTER		ADDRESS USAGE MODE
	A5	A4	A3	A2	A1	LISTEN	TALK	
00	0	0	0	0	0	SP	@	ADDRESSABLE
01	0	0	0	0	1	!	A	ADDRESSABLE
02	0	0	0	1	0	"	B	ADDRESSABLE
03	0	0	0	1	1	#	C	ADDRESSABLE
04	0	0	1	0	0	\$	D	ADDRESSABLE
05	0	0	1	0	1	%	E	ADDRESSABLE
06	0	0	1	1	0	&	F	ADDRESSABLE
07	0	0	1	1	1	'	G	ADDRESSABLE
08	0	1	0	0	0	(H	ADDRESSABLE
09	0	1	0	0	1)	I	ADDRESSABLE
10	0	1	0	1	0	*	J	ADDRESSABLE
11	0	1	0	1	1	+	K	ADDRESSABLE
12	0	1	1	0	0	,	L	ADDRESSABLE
13	0	1	1	0	1	-	M	ADDRESSABLE
14	0	1	1	1	0	.	N	ADDRESSABLE
15	0	1	1	1	1	/	O	ADDRESSABLE
16	1	0	0	0	0	0	P	ADDRESSABLE
17	1	0	0	0	1	1	Q	ADDRESSABLE
18	1	0	0	1	0	2	R	ADDRESSABLE
19	1	0	0	1	1	3	S	ADDRESSABLE
20	1	0	1	0	0	4	T	ADDRESSABLE
See Note Below → 21	1	0	1	0	1	5	U	ADDRESSABLE
22	1	0	1	1	0	6	V	ADDRESSABLE
23	1	0	1	1	1	7	W	ADDRESSABLE
24	1	1	0	0	0	8	X	ADDRESSABLE
25	1	1	0	0	1	9	Y	ADDRESSABLE
26	1	1	0	1	0	:	Z	ADDRESSABLE
27	1	1	0	1	1	;	[ADDRESSABLE
28	1	1	1	0	0	<	\	ADDRESSABLE
29	1	1	1	0	1	=]	ADDRESSABLE
30	1	1	1	1	0	>	~	ADDRESSABLE
31	1	1	1	1	1	N/A	N/A	TALK ONLY

Note: Be sure that the instrument address is not set to the same address as the controller. Typical HP controllers use address "21" as a preset address, thus the use of address "21" as the HP 5350A/51A/52A address code should be avoided.

3-247. The examples used in this section assume an address setting of 14. When using a controller such as an HP 9826A, 9836A, 9845A, or HP-85 calculator, the controller addresses the HP 5350A/51A/52A by using select code 7, plus the instrument address. Therefore, all examples in this manual will use the code 714 to address the HP 5350A/51A/52A to talk or listen. The ASCII characters for this same address setting are "N" for a talk address, and "." for a listen address. The ASCII characters are used when the controller is an HP 9830A calculator.



3-248. Interface Commands

3-249. The commands the counter recognizes can be separated into two classes: device independent commands and device dependent commands. Device independent commands are defined by the interface standard document and are the same in all instruments. These commands are identified by a three letter mnemonic such as GTL, which represents Go to Local. Device independent commands are sent as encoded bytes on the interface and not as ASCII strings. Thus these commands cannot be sent using the OUTPUT statement on the HP-85. However, many controllers do incorporate a command of the form SEND7;CMDnnn, where nnn is the decimal equivalent to the bit pattern corresponding to a particular device independent command. A detailed description of Device Independent Commands begins at paragraph 3-251.

3-250. Device dependent commands are unique to the instrument and are defined by the instrument designer. They are normally sent to an instrument as ASCII strings. A detailed description of Device Dependent Commands begins at paragraph 3-273.

3-251. Device Independent Commands

3-252. A list of supported independent command mnemonics, and the full name of each command, is given in Table 3-9.

Table 3-9. Device Independent Commands

Mnemonics	Command Name
ATN	Attention
DCL	Device Clear
EOI	End Or Identify
GET	Group Execute Trigger
GTL	Go To Local
IFC	Interface Clear
LADn	Listen Address n
LLO	Local Lockout
MLA	My Listen Address
MTA	My Talk Address
NRE	Not Remote Enable
NUL	Null
REN	Remote Enable
SDC	Selected Device Clear
SPD	Serial Poll Disable
SPE	Serial Poll Enable
TADn	Talk Address n
UNL	Unlisten
UNT	Untalk

3-253. A brief description of each device independent command, and the instrument response to each command is listed below:

- ATN Alerts the instrument that a device independent message is being sent, so the instrument is ready to accept data on the data lines, and interpret it as commands.
- DCL This command clears all errors, aborts all partially completed commands and pending send data commands, and clears all input and output buffers.
- EOI If ATN is false and the instrument is a listener, EOI acts as a message delimiter, and indicates the last data byte of a multi-byte sequence.



- GET If the instrument is addressed to listen, GET aborts the current measurement, and triggers the next measurement immediately. It is equivalent to pressing the TRIGGER key.
- GTL If the instrument is addressed to listen, GTL returns the instrument to (local) front panel operation. Local Lockout is not cleared.
- IFC The instrument untalks and unlistens, and the interface initializes to an idle state (no activity on the bus).
- LADn If n matches the instrument address, the instrument becomes a listener.
- LLO The front panel RESET/LOCAL key is disabled, if the instrument is in remote.
- MLA MLA is the listen address (LADn) that matches the instrument address.
- MTA MTA is the talker address (TADn) that matches the instrument address.
- NRE The instrument returns to (local) front panel operation; Local Lockout is cleared.
- NUL No effect when received by the instrument.
- REN The instrument enters the remote state, and is enabled to respond to interface commands when addressed as a listener.
- SDC If the instrument is a listener, will cause the same response as DCL.
- SPD Terminates serial polling, and returns the instrument to a normal talker state, to output device dependent data rather than status information.
- SPE Establishes serial polling, and enables the instrument to send the serial poll status byte, when addressed to talk.
- TADn If n matches the instrument address, the instrument becomes a talker.
- UNL The instrument is unaddressed and terminates listening. A single device cannot be unaddressed without unaddressing all listeners.
- UNT Unaddresses the instrument, if currently a talker, and terminates talking. Addressing another talker on the interface automatically unaddresses any current talker.

3-254. Meta Messages

3-255. To simplify the use of the HP-IB interface, Hewlett-Packard has developed what is called the Meta Message concept. Rather than requiring the user to remember all the device independent messages and their interactions, useful sequences of these commands have been integrated into a single command on many of HP's controllers. For example, to clear the instrument at address 14 using the device independent commands, it is necessary to send the sequence ATN, UNL, MTA, LAD 14, SDC. The HP-85 command, CLEAR714, sends the same sequence with no further user interaction. This greatly simplifies the use of the interface.

3-256. Many of the meta messages implemented on the HP-85 may be sent in either of two forms, with addressing or without addressing. The form with addressing will normally address a particular device to listen. For example, the command REMOTE7 will send REN without making any device a listener; while the command REMOTE714 will send REN, and then make the device at address 14 a listener. In the following tables, the form with addressing is shown.



3-257. Through meta messages, devices on the bus can exchange control and measurement information. A description of these messages, and the response of the HP 5350A/51A/52A to each message is provided in *Table 3-10*. Also included is the typical interface message sequence that corresponds to each meta message. The interface message sequences are typical in that different controllers may send different sequences for a given meta message, but will produce the same results.

Table 3-10. Meta Messages

Message	Description	HP 5350A/5351A/5352A Response
DATA	Transfers device dependent information from one device to one or more devices on the bus. (UNL, MTA, LADn, data)	The 5350A/51A/52A sends measurement data as defined by the device dependent command received from the controller.
TRIGGER	Causes a group of selected devices to simultaneously initiate a set of device dependent actions. (UNL, MTA, LADn, GET)	Starts a new measurement (if Sample Rate is set to Hold.)
CLEAR	Causes an instrument to be set to a predefined state, such as a certain range or function. (UNL, MTA, LADn, SDC)	Causes the counter to clear any errors present, clears all input and output buffers, and resets the hardware for a new measurement.
REMOTE	Permits selected devices to be set to remote operation, allowing parameters and device characteristics to be controlled by bus messages. (REN, UNL, MTA, LADn)	Causes the counter to go to remote operation if REN is true, and counter is addressed to listen. Locks out all front panel keys except RESET/LOCAL; counter is controlled by bus messages. Until changed via the bus, remote operation is according to state of front panel settings just prior to going to Remote. (For exceptions, refer to paragraph 3-259, Remote Versus Local Measurements.)
LOCAL	Causes selected devices to return to local (front panel) operation. (UNL, MTA, LADn, GTL)	Returns the counter to front panel control. Counter status is that set just prior to receipt of the Local message. (For exceptions, refer to paragraph 3-259, Remote Versus Local Measurements.) NOTE: The 5350A/51A/52A does not respond to any device dependent commands when in Local operation.
LOCAL LOCKOUT	Disables local (front panel) controls of selected devices. (LLO)	Disables RESET/LOCAL key. Counter remains in remote operation until a Local message is received on the bus.
LOCAL/CLEAR LOCAL LOCKOUT	Returns all devices to local (front panel) control and simultaneously clears the local lockout message. (LCLL)	Returns counter to local (front panel) control and clears the Local Lockout message.



Table 3-10. Meta Messages (Continued)

Message	Description	HP 5350A/5351A/5352A Response
SERVICE REQUEST	Indicates a device's need for interaction with the controller. (SRQ)	This message is ignored by the counter when received. The counter will send a Service Request message to the controller under certain conditions. (Refer to paragraph 3-261, SRQ and Status Byte, and paragraph 3-268, Service Request Mask.)
STATUS BYTE	Presents status information of a particular device; one bit indicates whether or not the device currently requires service, the other 7 bits (optional) are used to indicate the type of service required. (UNL, MLA, TADn, SPE, data, SPD, UNT)	Counter sends status information to the controller. The assignment of the bits in the Status Byte are shown in Table 3-12. (Refer to paragraph 3-261, SRQ and Status Byte, and paragraph 3-268, Service Request Mask.)
STATUS BIT	A single bit of device-dependent status information which may be logically combined with status bit information from other devices by the controller.	Does not use.
PASS CONTROL	Passes bus controller responsibilities from the current controller to a device which can assume the bus supervisory role.	Does not use.
ABORT	Unconditionally terminates bus communications and returns control to the system controller. (IFC)	All HP-IB activity terminated and control returns to the system controller. Talk and Listen is cleared for the counter and all other devices on the bus, which terminates all bus communications. Counter status remains as it was just prior to receipt of the Abort message. Any partially entered HP-IB data message is aborted.

3-258. Meta messages and the HP 9825 HPL and HP-85 BASIC commands which correspond to them are listed in Table 3-11. (Only the addressed form is shown for the commands that support both the unaddressed and addressed forms.) The table assumes the instrument is set at address 14 and the interface is set at select code 7.



Table 3-11. Meta Messages and Controller Commands

MESSAGE	HP 9825 HPL	HP-85 BASIC
DATA	wrt 714; A\$ red 714; A\$	OUTPUT 714; A\$ ENTER 714; A\$
TRIGGER	trg 714	TRIGGER 714
CLEAR	clr 714	CLEAR 714
REMOTE	rem 714	REMOTE 714
LOCAL	lcl 714	LOCAL 714
LOCAL/ CLEAR LOCAL LOCKOUT	lcl 7	LOCAL 7
LOCAL LOCKOUT	llo 7	LOCAL LOCKOUT 7
SERVICE	rds (7) → A	STATUS 7, 2; A
STATUS BYTE	rds (714) → A	A = SPOLL (714)
ABORT	cli	ABORTIO 7

3-259. Remote Versus Local Measurements

3-260. The measurement cycle performed by the HP 5350A/51A/52A when in Remote differs from that performed when the instrument is making a Local measurement. When in Local, harmonic number determination takes place once every measurement cycle. In Remote, harmonic number determination takes place every 10 measurements. The "HARMDET" command may be used to set the harmonic number determination to take place after a desired number of measurements (when in Remote), as described in paragraph 3-327. If the counter is returned to Local after a "HARMDET" command has been passed, the number of measurements set by the "HARMDET" command are lost, and the counter returns to determining the harmonic number every measurement (in Local), or every 10 measurements (if returned to Remote operation).

3-261. SRQ and Status Byte

3-262. The counter can send a service request (SRQ) to the controller to indicate the need for attention, and can interrupt the current sequence of events. Typically, SRQ indicates data is ready to transmit and/or an abnormal condition exists. The counter sends an SRQ to the controller after a 0 to 1 transition of an enabled condition, as defined by the Service Request Mask. The Service Request Mask (SRQMASK command) must be set prior to the conditions, as described in paragraph 3-268. The HP 5350A/51A/52A can send an SRQ to the controller under any, or all, of the following conditions:

Power On: The POWER switch has been set to ON, and the power-up test is completed.

Local: The counter is under local control.

Overload: An overload condition exists on INPUT 1.

Error: An Error condition exists.

Measurement Complete: A measurement has been completed and is available for collection. Most useful when the sample rate is set to HOLD (for triggered measurements).

Data Ready: Query result ready. The counter has responded to a request for data, and is ready to output the data.



3-263. In general, the controller can read the counter Status Byte, shown in *Table 3-12*, at any time to check selected operating conditions. During remote operation, the Service Request Mask command (SRQMASK,n) may be used to identify the conditions which you feel may require service or data collection, by masking selected bits of the Status Byte.

Table 3-12. HP 5350A/5351A/5352A Status Byte

D7	D6	D5	D4	D3	D2	D1	D0
(Always zero)	RQS FLAG	POWER ON	LOCAL	OVERLOAD	ERROR	MEAS. COMPLETE	DATA READY
128	64	32	16	8	4	2	1

3-264. Once SRQ has been sent, the controller identifies which condition or conditions caused the Service Request by conducting a Serial Poll of all devices on the bus, reading the Status Byte from each device. For example, with the HP-85, "A=SPOLL (714)" requests the 8-bit binary Status Byte, and sets the variable "A" equal to the value of the Status Byte. When the HP 5350A/51A/52A Status Byte is read, conditions that exist will be set to 1, whether or not they were enabled as a condition to generate SRQ.

3-265. The number returned will be a decimal equivalent to the sum of the different status bits that have been set. For example, the instrument sends a service request (SRQ), and reading the Status Byte returned a value of "70". This number (64+4+2=70) signifies: the RQS FLAG (Request for Service) is set, there is an error, and the measurement is complete. All bits of the Status Byte (except D6 and D7) are set (bit = 1) or cleared (bit = 0) regardless of the Service Request Mask. Bit D7 is not used (i.e. it is always zero), and bit D6 (RQS FLAG) is only set if one of the other bits in the Status Byte is enabled as a condition to generate an SRQ by the setting of the Service Request Mask. The special function of the RQS FLAG bit is explained in the Service Request Mask description, beginning at paragraph 3-268.

3-266. The Status Byte can be displayed by executing the "DISP A" statement after the "A=SPOLL (714)" command (if using the HP-85). The display will be the decimal equivalent to the sum of the different status bits that have been set. With the HP 9825A, the command "rds 714-A" requests the Status Byte, and "dsp A" sends the status to the HP 9825A display.

3-267. Status Byte Bit Descriptions

- POWER ON:** The Power On bit (D5) is set after the power-up self test and HP-IB initialization is completed.
- LOCAL:** The Local bit (D4) is set when the instrument is in local, and cleared when the instrument is in remote. This bit may be used to detect that the user has returned the counter to local by pressing the front panel RESET/LOCAL key.
- OVERLOAD:** The Overload bit (D3) is set when the INPUT 1 detector signals an overload condition exists. When the input power drops below the overload threshold, the overload bit is cleared.
- ERROR:** The Error bit (D2) is set whenever an error has been detected. It is cleared only after the error has been cleared by a "RESET", "INIT", "CLR" or Selected Device Clear command (via HP-IB), or by pressing the front panel RESET/LOCAL key.



MEASUREMENT

COMPLETE: The Measurement Complete bit (D1) is set at the end of a measurement, and cleared when a new measurement is begun. When the sample rate is set to "FAST", this bit will be set only briefly. To guarantee that the controller will "catch" this bit, the counter sample rate should be set to "HOLD". In this case, the Measurement Complete bit is set at the end of the measurement, and is cleared after a trigger initiates a new measurement. The Measurement Complete bit is also cleared by a serial poll.

DATA READY: The Data Ready bit (D0) is set whenever the interface output buffer contains data to be sent over the bus. Note that the Data Ready bit is set for any output, while the previously described Measurement Complete bit (D1) applies to measurements only.

3-268. Service Request Mask

3-269. To select the conditions which may require service or data collection, the SRQMASK command can be used to determine which of the bits in the Status Byte will generate an SRQ. Any bit in the Status Byte, with the exception of the RQS bit (D6) and the POWER ON bit (D5), can be masked so it will not generate an SRQ, even though the condition exists. To specify the service request mask, send the SRQMASK command followed by a decimal number (SRQMASK,n), representative of the binary sum of the bits that you want enabled (unmasked). The value of "n" may be any number from 0 to 255. All SRQ conditions can be masked (disabled) by sending "SRQMASK,0". If all SRQ conditions are masked, none of the conditions will generate an SRQ.

3-270. Upon receipt of the "SRQMASK,n" command, the instrument will load the binary value of "n" into the service request mask register. Each bit in the "n" value corresponds to a bit in the Status Byte, as shown in Table 3-13.

Table 3-13. HP 5350A/5351A/5352A Service Request Mask

	D7	D6	D5	D4	D3	D2	D1	D0
Service Request Mask	(Don't care)	(Don't care)	(Don't care)	LOCAL	OVER-LOAD	ERROR	MEAS. COMPLETE	DATA READY
Status Byte	(Always zero)	RQS FLAG	POWER ON	LOCAL	OVER-LOAD	ERROR	MEAS. COMPLETE	DATA READY
Binary Weight	128	64	32	16	8	4	2	1

3-271. For example, sending the command "SRQMASK,13" will generate a service request (SRQ) and set Bit 6 (RQS), after an overload or error condition is generated, or when data is ready (8+4+1). The RQS bit (D6) in the Service Request Mask is labeled "don't care" because the SRQ line/RQS bit will be set true ONLY if one of the other bits in the Status Byte becomes true, and the corresponding bit in the Service Request Mask is set. Therefore, the command "SRQMASK,77" is equivalent to the command "SRQMASK,13."

3-272. SRQ is asserted when one of the enabled (unmasked) conditions changes from 0 to 1. SRQ is negated (released) after a serial poll. However, the RQS bit in the Status Byte (and the front panel SRQ annunciator) remains set as long as the enabled condition(s) is true (1).



3-273. Device Dependent Commands

3-274. A device dependent command is a sequence of ASCII-coded bytes sent to the HP 5350A/51A/52A over the HP-IB that causes the counter to perform a specific function. There are two types of device dependent commands: “program messages”, which change the state of the instrument and/or the instrument function settings, and “queries”, which do not change function settings, but cause the instrument to return data to the controller (instrument identification, measurement setup data, etc.). The following paragraphs describe how to use the device dependent commands to program the HP 5350A/51A/52A.

3-275. HP-IB COMMAND CODES

3-276. Almost all counter local functions are programmable with individual command codes via the HP-IB. In general, functions operate the same in remote as in local (For an exception, refer to paragraph 3-259, Remote Versus Local Measurements). The counter may also be programmed to perform a number of functions for which there are no front panel keyboard equivalents. The following paragraphs contain a description of the HP-IB command syntax for programming the HP 5350A/51A/52A, and a listing of all programming commands for the counter.

3-277. All local functions, except for POWER, SET/ENTER, and HP-IB ADDRESS, are programmable via the HP-IB. Most of the programmable functions have the corresponding HP-IB command mnemonic underlined on the front panel key label (for example, RESOLUTION). Those functions which are not underlined are shown below:

Function Key	HP-IB Mnemonic
50Ω	LOWZ
1MΩ	HIGHZ

3-278. HP-IB Command Syntax Diagrams

3-279. In the following paragraphs, HP-IB command syntax is represented pictorially, to explain the format in which HP-IB programming commands should be sent to the instrument. All characters enclosed by a rounded envelope must be entered exactly as shown. Words enclosed by a rectangular box are names of items used in the commands, and are described in the text. Items contained within circles indicate required literals which must occur in the command syntax exactly as shown.

NOTE

Spaces are not shown in all places where they may occur. Spaces between command mnemonics and data are allowed in the command string to gain greater clarity, but spaces within command mnemonics, and within data are NOT ALLOWED.

3-280. Command elements, connected by lines, can be followed in only one direction, as indicated by the arrowhead at the end of the line. Any combination of command elements that can be generated by following the lines in the proper direction is syntactically correct.

3-281. Command Syntax Overview

3-282. There are four possible types of command elements: command mnemonics (referred to as “headers”), data, program message separators, and data separators. A command can consist of a header alone or a header followed by one or more fields of data. A separator is required between headers and data, between data fields, and between each command, as shown in Figure 3-5.

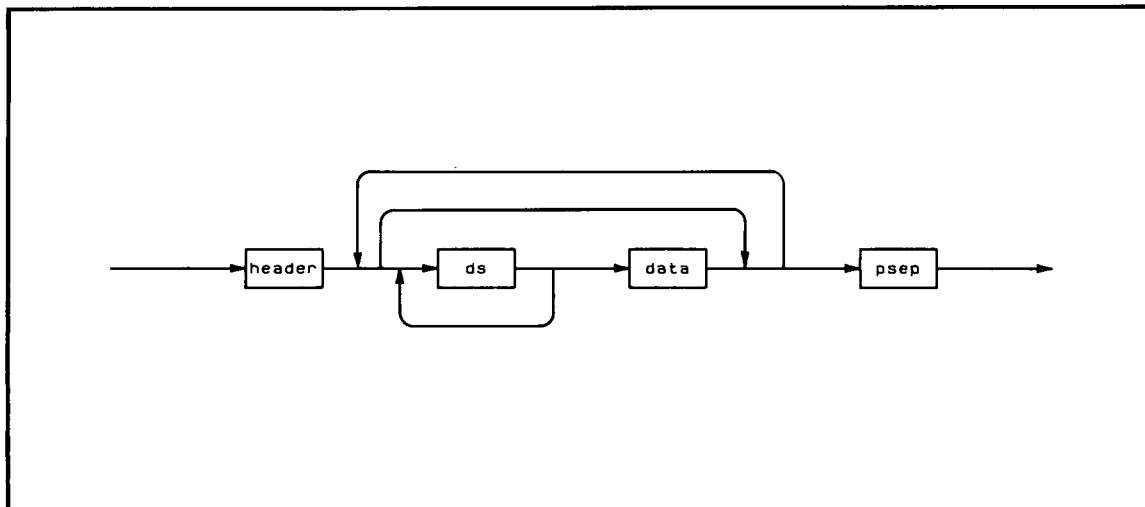

Figure 3-5. Program Command Syntax

3-283. Command Headers

3-284. All HP-IB commands require a command header. Command headers, where possible, consist of the full English word for the corresponding function, up to a maximum of eight characters in length. Functions which would require more than eight characters, or more than one word, are abbreviated. Commands which cause data to be returned to the controller (queries) include a question mark (?) as the last character of the header.

3-285. Table 3-14 contains a summary of all the command headers for the HP 5350A/51A/52A. The table is divided into two parts: program message headers, and query headers.



Table 3-14. HP 5350A/51A/52A Programming Command Headers

Program Message Headers:	
RESET	Restart measurement; clear any errors.
CLR	Same as Device Clear message.
INIT	Instrument initialization.
AUTO	Input 1, Auto mode.
MANUAL	Input 1, Manual mode.
LOWZ	Input 2, 50Ω.
HIGHZ	Input 2, 1MΩ.
TRIGGER	Trigger.
TRG	Same as Trigger.
RESOL	Resolution.
SAMPLE	Sample Rate.
FMRATE	FM Rate Tolerance.
OFFSET	Offset.
SCALE	Scale.
SMOOTH	Smooth.
HIRESOL	High Resolution.
DIAG	Diagnostics.
DIAGPARM	Diagnostic parameter.
DISPLAY	Message display/Display concealment.
SRQMASK	Service request mask.
DUMP	Fastest measurement: 80 readings/second.
SET	Accept instrument setup.
SLEEP	Disable INPUT 1 circuit.
HARMDET	Harmonic number determination.
Query Headers:	
TEST?	Send Self Check results.
DIAG?	Send diagnostics results.
KEY?	Send number of last key pressed.
ID?	Send device model number.
SET?	Send instrument setup.
ERR?	Send error number.
REV?	Send firmware revision date code.
SER?	Send serial number.
REF?	Send timebase reference status.
OVEN?	Send oven status.

3-286. The instrument will accept commands in either upper or lower case. All characters are converted to upper case before interpretation. In addition, parity bits are ignored. The following commands will produce identical results:

OUTPUT 714; "OFFSET, LASTF, ON"
OUTPUT 714; "Offset, LastF, On"



3-287. Data Separators

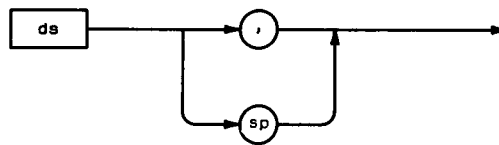

Data separators ARE REQUIRED between headers and data, and between data fields. A <comma> is the preferred separator, but a <space> may also be used as a separator. In the detailed command syntax diagrams, both types of separators are represented by “ds”, as shown above.

3-288. Command Separators

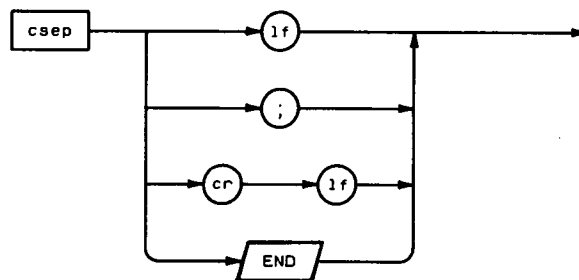

Command separators ARE REQUIRED. In the detailed command syntax diagrams, the command separators are not shown.

NOTE

The END command separator is only sent with the last byte of the command.

3-289. Data

3-290. Commands may have none, one, or two pieces of data sent as part of the command. There are three types of data associated with program messages: numeric, character, and string. Numeric data is used for function settings which require the entry of a number, while character data is used for function settings which are not inherently numeric. Character data is also used for binary conditions (i.e. On/Off settings). String data is used for displaying messages on the 24-character Liquid Crystal Display on the front panel, and for sending the setup information (“SET”) command.

3-291. Numeric Data

3-292. Numeric data applies to those functions which require the entry of a number, such as Manual Center Frequency, Offset Frequency, Scale, and others. Numeric data entry is a “free-format” input, with spaces allowed before and after a numeric character is entered. Spaces are NOT allowed within a number. A decimal point and an exponent are allowed, but not required.



3-293. Numeric data, if required by a program message, may be entered in integer, real, or floating point form. These numeric forms correspond to the data types (nr1, nr2, and nr3, respectively) described in IEEE-728 Codes and Formats Guidelines. For example, the following command strings are permitted, and are equivalent:

OUTPUT 714; "MANUAL, 500000000"
OUTPUT 714; "MANUAL, 5E+08"

3-294. Program messages requiring the integer form of numeric data (for example, "RESOL" or "DIAG") will round any non-integer data to the nearest integer. For example, the following command strings are permitted, and are equivalent:

OUTPUT 714; "RESOL, 0.9"
OUTPUT 714; "RESOL, 1"

3-295. Figure 3-6 shows the preferred syntax for each numeric data type.

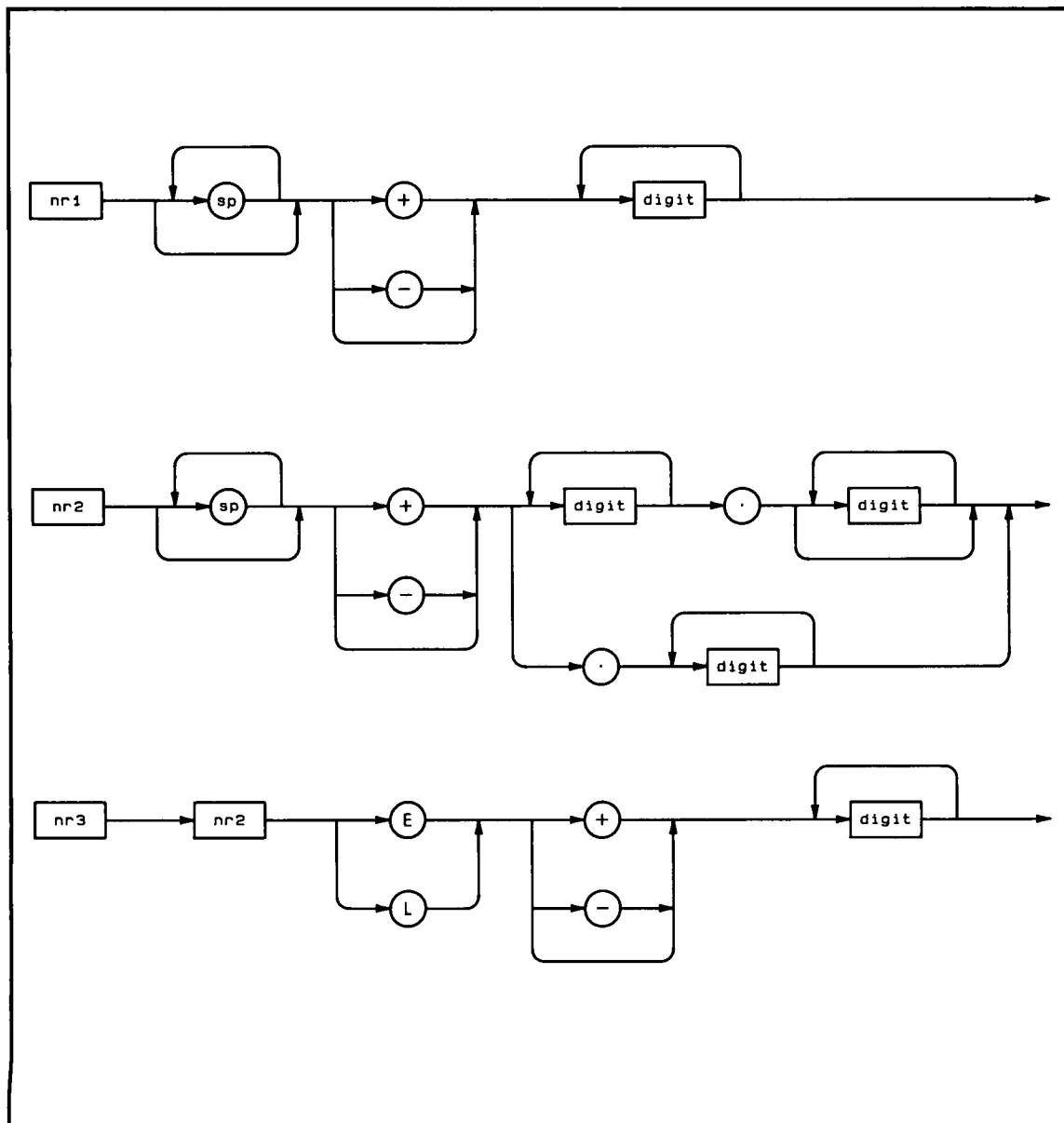

Figure 3-6. Numeric Data Types



3-296. Character Data

3-297. Character data is used for those function settings which are not inherently numeric, such as the FAST or HOLD setting for the Sample Rate function. Character data is also used for setting binary conditions, such as the ON/OFF setting of the Smooth function. *Table 3-15* lists all the allowable character data which may be included in a command to the HP 5350A/51A/52A.

Table 3-15. Character Data

Data	Definition
ON	Turn function on.
OFF	Turn function off.
LASTF	Use last measurement as frequency value.
NORMAL	Set FM Rate Tolerance for NORMAL FM rate.
LOW	Set FM Rate Tolerance for LOW FM rate.
FAST	Repeat measurement as quickly as possible.
HOLD	Hold last measurement until new measurement is triggered.

3-298. String Data

3-299. String data is similar to character data except that the characters are enclosed in quotes. This format allows special characters, such as <comma>, <space>, and <semicolon>, to be passed as data. String data is used with the "DISPLAY" command for displaying messages on the front panel LCD, and by the "SET" command to allow passing of ASCII hexadecimal characters over the HP-IB. Refer to the descriptions of the "DISPLAY" and "SET" commands in the detailed command descriptions beginning at paragraph 3-302.

3-300. Frequency Specifier

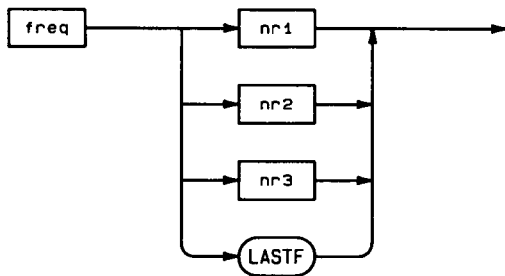

3-301. A frequency may be specified by an explicit number or "LASTF" (the last measurement). All frequencies entered are in Hertz units.

3-302. DETAILED COMMAND SYNTAX DESCRIPTIONS

3-303. The following paragraphs briefly describe each of the commands for the HP 5350A/51A/52A. Each program message and query listed is accompanied by a syntax diagram, as described in paragraph 3-278.

3-304. All query commands return data to the controller, as discussed in the query descriptions beginning at paragraph 3-328. Each query description includes information on the output format resulting from a given query. Refer to paragraph 3-338, HP-IB Data Output, for a general description of output formats.

COMMAND SYNTAX DESCRIPTIONS



3-305. RESET: Instrument Reset

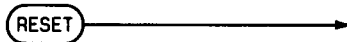

This program message performs the same function as the RESET/LOCAL key when in local. The current measurement is aborted, errors are cleared, input and output buffers are cleared, and any partially entered key sequence or HP-IB command is aborted. In addition, the diagnostics mode, if active, is exited.

3-306. CLR: Instrument Clear

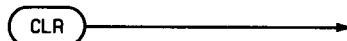

This program message has the same effect as the Device Clear message. The current measurement is aborted, errors are cleared, input and output buffers are cleared, and any partially entered key sequence or HP-IB command is aborted.

3-307. INIT: Instrument Initialization

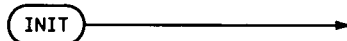

This program message sets the instrument to the same state as the plug-in power-up state except that the HP-IB interface is unaffected. Errors are cleared, input and output buffers are cleared, "DUMP" mode is turned off, "SLEEP" mode is turned off, and keyboard and display lockouts (Diag 98,99), if active, are cleared. The "INIT" command is the only command (other than the "DUMP OFF" command) that should be sent to the counter when DUMP mode is enabled; any other commands will give unpredictable results.

NOTE

Since the "RESET", "CLR", and "INIT" commands clear the input buffers, they should be sent so that no new input will be handshaken in until the last command is processed. Typically, this means the command should be sent by itself as a separate command, as in the following HP-85 examples:

```
OUTPUT 714; "RESET"  
OUTPUT 714; "CLR"  
OUTPUT 714; "INIT"
```

Placing the command at the end of a string of commands, as shown below, would have the same effect:

```
OUTPUT 714; "OFFSET, ON; AUTO; RESET"  
OUTPUT 714; "OFFSET, ON; AUTO; CLR"  
OUTPUT 714; "OFFSET, ON; AUTO; INIT"
```



COMMAND SYNTAX DESCRIPTIONS

3-308. AUTO: Automatic Measurement Mode

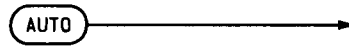

This program message has the same effect as the AUTO key on the front panel (selects INPUT 1, Automatic mode). The current measurement cycle is aborted.

3-309. MANUAL: Manual Measurement Mode



This program message has the same effect as the MANUAL key on the front panel (selects INPUT 1, Manual mode). A Manual Center Frequency parameter may be specified, in Hertz. If no frequency parameter is passed, or if "LASTF" is passed, the last measurement is used as the Manual Center Frequency. The current measurement cycle is aborted.

3-310. LOWZ: Input 2, 50Ω Measurement Mode



This program message has the same effect as the 50Ω key on the front panel (selects INPUT 2, 50Ω input impedance). The current measurement cycle is aborted.

3-311. HIGHZ: Input 2, 1MΩ Measurement Mode

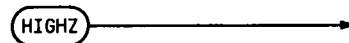

This program message has the same effect as the 1MΩ key on the front panel (selects Input 2, 1MΩ input impedance). The current measurement cycle is aborted.

3-312. TRIGGER and TRG: Trigger

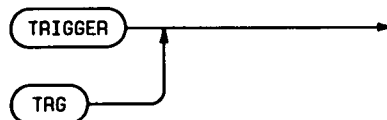

This program message has the same effect as the TRIGGER key on the front panel, starting a new measurement when the instrument sample rate is set to HOLD. If not in HOLD, current measurement is aborted.

COMMAND SYNTAX DESCRIPTIONS



3-313. RESOL: Resolution



This program message sets the resolution to values ranging from 1 Hz through 1 MHz, in decade steps. The resolution is set by sending an integer (preferred) with the “RESOL” header; non-integer data will be rounded. The corresponding resolution is shown below:

Numeric Data	Resolution
0	1 Hz
1	10 Hz
2	100 Hz
3	1 kHz
4	10 kHz
5	100 kHz
6	1 MHz

3-314. SAMPLE: Sample Rate

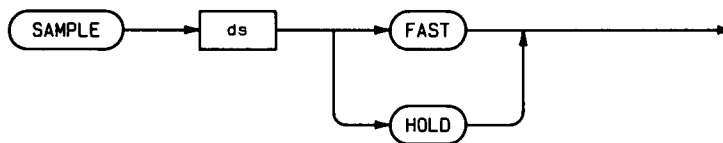

This program message chooses one of two sample rates. “FAST” will allow the instrument to repeat measurements as quickly as possible. When in “HOLD”, a new measurement will be started only after a “TRIGGER” or “TRG” program message, or a Group ExecuteTrigger (GET) on the bus.

3-315. FMRATE: FM Rate Tolerance

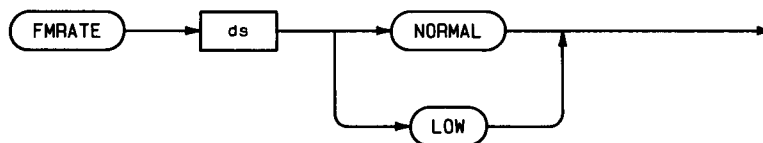

This program message sets the FM Rate Tolerance of the instrument to “NORMAL” (normal FM rate) or “LOW” (low FM rate). Refer to paragraphs 3-25 and 3-100 for a description of the FM Rate Tolerance function.



COMMAND SYNTAX DESCRIPTIONS

3-316. OFFSET: Offset

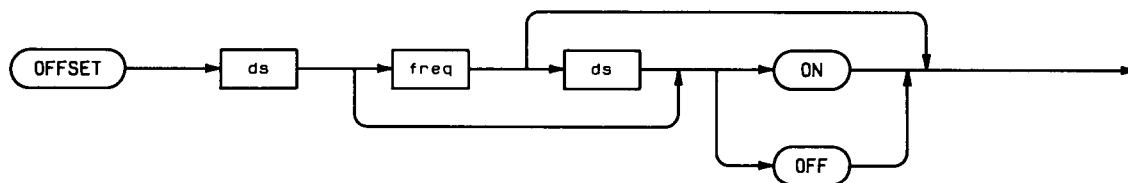

This program message is used to turn the Offset function on or off, and to set the offset frequency. Setting the offset frequency without specifying "ON" or "OFF" turns the Offset function ON automatically. The frequency may be positive or negative, to add or subtract the value from the measured frequency. If "LASTF" is passed, the last measured frequency, negated, is entered as the offset value. Frequencies entered are in Hertz units.

3-317. SCALE: Scale

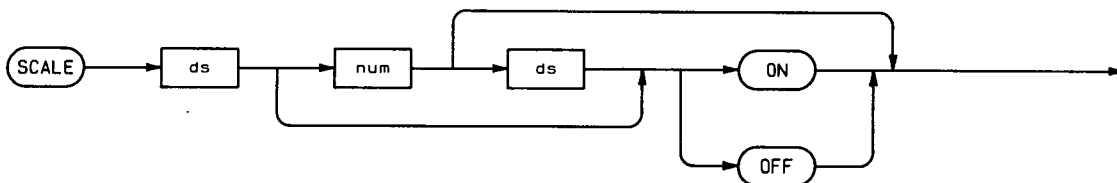

This program message turns the Scale function on or off, and/or sets the value. Setting the Scale value without specifying "ON" or "OFF" automatically turns ON the Scale function.

3-318. SMOOTH: Smooth

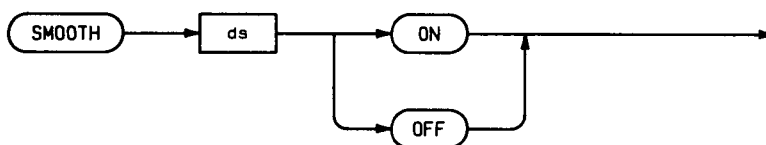

This program message turns the Smooth function on or off. The Smooth algorithm and measurement cycle are restarted.

3-319. HIRESOL: High Resolution

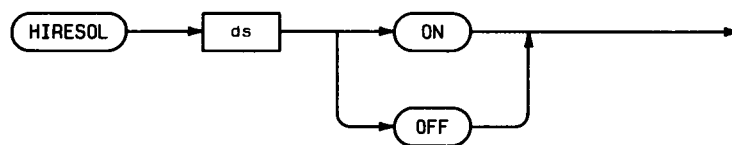

This program message has the same effect as the HIGH RESOL key on the front panel, turning the High Resolution function on or off.

COMMAND SYNTAX DESCRIPTIONS



3-320. DIAG: Diagnostic

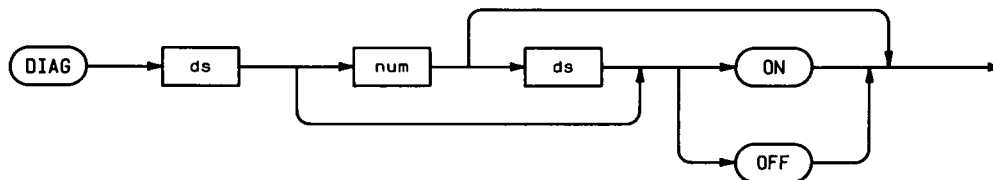

Most diagnostics may be set up over HP-IB using this program message. All diagnostics except Diag 1, 41, 42, 43, 44, and 80 are available over the bus. Some diagnostics return data over the bus, while others require an oscilloscope or additional equipment. To get a diagnostic result over the bus, send the query DIAG?. Refer to paragraph 3-344 for a description of the diagnostic data returned to the controller.

NOTE

Diagnostic failures are not treated as errors. The Error bit in the serial poll byte is not set.

NOTE

There are three diagnostics which cannot be exited using the "DIAG,OFF" command. Diag 97 (IF 175 MHz Filter Adjust) can only be exited by powering down the counter (POWER switch to STBY). Diag 98 (Keyboard Lockout) and Diag 99 (Display Lockout) can also be cleared by powering down the counter, or by sending the "INIT" command.

3-321. DIAGPARM: Diagnostic Parameter

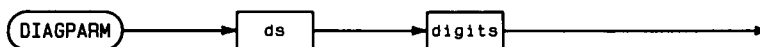

Diag 51 (Synthesizer Verification - User-Entered Frequency) requires a parameter after the "DIAG" program message is passed. As many "DIAGPARM" program messages as necessary may be entered immediately following the enabling of Diag 51. Refer to the diagnostic descriptions in Section VIII, Service, for information on diagnostic parameters.



COMMAND SYNTAX DESCRIPTIONS

3-322. DISPLAY: Remote Display

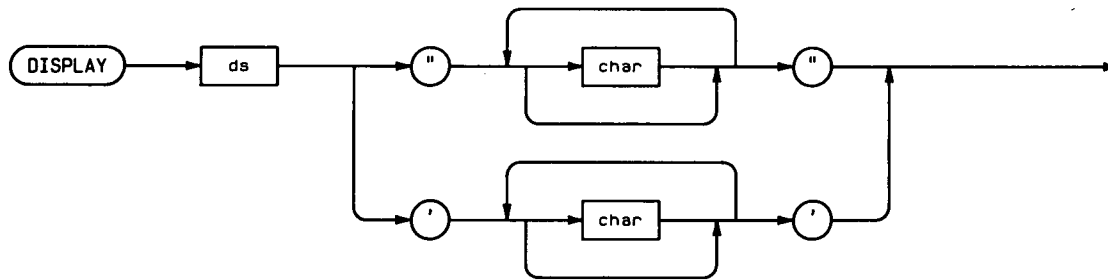

This program message allows an arbitrary string of up to 24 uppercase letters, numbers, or punctuation to be displayed on the counter's front panel LCD. Embedded string delimiters are not allowed. To display a single quote, the string must be surrounded by double quotes. To display a double quote, the string must be delimited by single quotes. Embedded spaces, commas, and semi-colons are allowed. Periods are combined with the characters to the left, when displayed, so they are not counted in the 24-character limit. Up to 48 characters, including periods, will be accepted without error, but only the first 24 characters are displayed. The remainder of the string is ignored. The string is left-justified in the display area. Extra places are filled with blanks.

To turn off the message and return to normal display, a null (empty) string is sent. The "INIT" command also turns off the the remote display. To blank the display, a single blank, " ", may be sent.

The "DISPLAY" message supersedes all others while it is enabled, thus providing "display concealment" (equivalent to Diag 99 - Display Lockout). No measurements or error messages will be displayed while the remotely provided string is active. If the user goes to Local by pressing the RESET/LOCAL key, the remote message remains displayed. To return to the normal display, press the special key sequence 7, 4, 0, RESET/LOCAL, or momentarily disconnect the ac power to the instrument.

COMMAND SYNTAX DESCRIPTIONS



3-323. SRQMASK: Service Request Mask

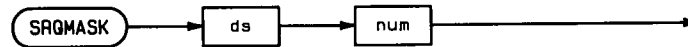

This program message sets the Service Request mask to cause a Service Request whenever an enabled condition changes from 0 to 1 in the Status Byte. To enable a condition, set the corresponding bit in the Service Request Mask to “1”, and to disable, set the bit to “0”, as shown below:

Binary	Decimal	Condition
0000 0000	0	No SRQ conditions enabled
0000 0001	1	Data Ready
0000 0010	2	Measurement Complete
0000 0100	4	Error
0000 1000	8	Overload
0001 0000	16	Local
00X0 0000	32	(Don't care)
0X00 0000	64	(Don't care)
X000 0000	128	(Don't care)

Conditions may be enabled singly or in any combination desired. For example, setting binary 0000 0110 (decimal 6) will cause a Service Request if either an error occurs or a measurement is completed. Any number between 0 and 255 may be sent. Refer to paragraph 3-268, Service Request Mask.

3-324. DUMP: Dump Mode

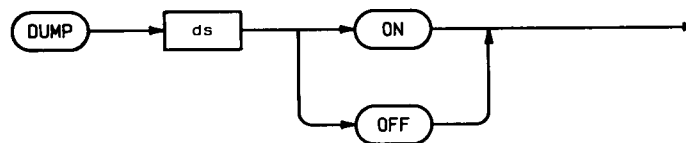

The “DUMP” mode provides faster reading capability. At least 80 measurements per second, at 10 kHz resolution, may be read. When “DUMP” is ON, the instrument displays “DUMPING---”. No annunciators are displayed, and the display is not updated. (The display will blank after 10 minutes. After “DUMP” is turned OFF, the display will behave normally.) Serial poll status is not updated.

The format of the frequency returned when in “DUMP” mode is optimized for speed. The data format is a 7-character numeric ASCII string, with no spaces or decimal points, of the form:

CGMMMkk ^ EOI

Where G = gigaHertz digits
M = megaHertz digits
k = kiloHertz digits
EOI = End or Identify
(sent with last digit as message terminator)

Leading zeros are not blanked. The returned value must be multiplied by 10 kHz to get the frequency value in Hertz.



COMMAND SYNTAX DESCRIPTIONS

NOTE

Before activating the "DUMP" mode, the instrument MUST be set as follows:

MANUAL, <freq>
RESOL, 4
OFFSET, OFF
SCALE, OFF
SMOOTH, OFF
SAMPLE, FAST

When DUMP mode is "ON", the only command that should be sent to the counter is "DUMP OFF" or "INIT". Any other commands will give unpredictable results.

3-325. SET: Instrument Setup

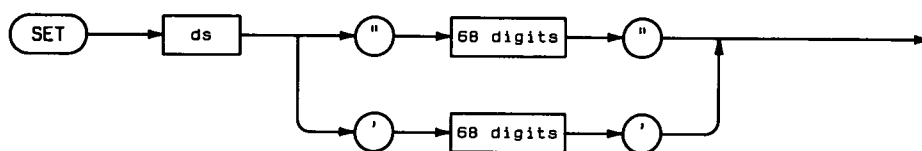

This program message sets up the instrument according to the data passed. The data is determined by a previous instrument setup saved using the "SET?" query. By using the "SET" and "SET?" commands together, different configurations may be saved, then restored with a single command. Measurement results are not saved.

Refer to the description of the "SET?" query at paragraph 3-332 for information concerning the "SET" data string.

3-326. SLEEP: Disable INPUT 1 Circuit

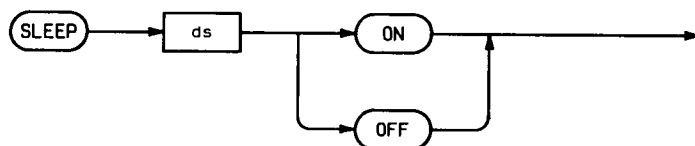

The "SLEEP" program message disables the high frequency input (INPUT 1) by turning off the A12 Microwave Assembly, thus minimizing the effect of having an input connected to the counter. This mode may be useful when several instruments are connected to one signal, and the 5350A/51A/52A is temporarily not being used for signal measurements. INPUT 1 measurements cannot be made when the "SLEEP" function is on. Passing the "OFF" parameter turns the A12 Assembly back on.

COMMAND SYNTAX DESCRIPTIONS



3-327. HARMDET: Harmonic Number Determination

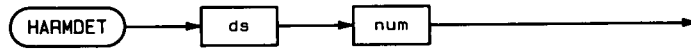

The "HARMDET" program message allows the user to select how often the harmonic number (N) determination occurs during measurements. In normal remote operation, harmonic number determination takes place every 10 measurements; in local operation, it occurs every measurement. The numeric data passed with the "HARMDET" command causes the N determination to take place after the chosen number of measurements. If the counter is returned to Local after the command is passed, the number of measurements set by the "HARMDET" numeric data are lost, and the counter returns to determining the N number every measurement (in Local), or every 10 measurements (if the counter is returned to Remote).

3-328. TEST?: Send Self Check Results



This query has an effect similar to pressing the SELF CHECK key on the front panel. After the self check is performed, the pass or fail result is sent to the controller over HP-IB. The result returned over the bus consists of 24 ASCII characters. The format is similar to the front panel display that would appear during a local Self Check, except that no decimal points are passed over HP-IB. (Refer to the Self Check display shown in paragraph 3-208.) If one or more failures occur, only the first failure is caught, after which the counter exits Self Check.

3-329. DIAG?: Send Diagnostic Results



This query will cause the current diagnostic result to be sent to the controller. The result returned over the bus consists of 24 ASCII characters, arranged in a format similar to the front panel display that would appear during a local diagnostic, except that no decimal points are passed over the HP-IB. Some of the displays contain measurements, such as the IF measurement during Diag 2. These measurements may be extracted from the Pass/Fail result by controller software. Refer to the diagnostic descriptions in Section VIII, Service.

*What happens if not in DIAGNOSTICS?
when query received?*



COMMAND SYNTAX DESCRIPTIONS

3-330. KEY?: Send Number of Last Key Pressed

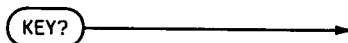

This query causes the instrument to return a number corresponding to the last key pressed, as shown below (refer to paragraph 3-348, Numeric Output Format):

KEY CODE	KEY NAME	KEY CODE	KEY NAME
0	No Key	11	DIAGNOSTICS/1
1	RESET/LOCAL	12	HP-IB ADDRESS/4
2	OFFSET/LST FRQ	13	TRIGGER/.
3	SMOOTH/DEC ←	14	SELF CHECK/8
4	SCALE/INC →	15	FM RATE TOL/2
5	SET/ENTER	16	HIGH RESOL/5
6	----	17	MANUAL/±
7	----	18	50Ω/9
8	----	19	AUTO/3
9	SAMPLE RATE/0	20	1MΩ/6
10	RESOLUTION/7		

3-331. ID?: Send Identity

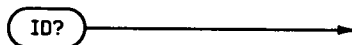

This query causes the counter to return a 7-character string containing the model number of the instrument, in the form: "53xxa", where "xx" represents the numeric portion of the instrument model number, and 'a' represents the alpha portion.

3-332. SET?: Send Instrument Setup

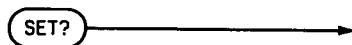

The instrument responds to this query by sending an ASCII-encoded "binary" string specifying the current instrument setup.

The data message returned in response to this query, if sent back as received (using the "SET" command), will completely set up the instrument. A 34-byte block of data from the A4 microprocessor's internal RAM is sent to the controller. This block of binary bytes is converted into a 68-byte string of hexadecimal characters. The string is not enclosed in quotes.

COMMAND SYNTAX DESCRIPTIONS



3-333. ERR?: Send Error Number

ERR? →

This query causes the instrument to send to the controller a message indicating the current error. If there is no error, the number returned is 0. Otherwise, the error number is returned. Refer to paragraph 3-348, Numeric Output Format.

3-334. REV?: Send Firmware Revision Datecode

REV? →

This query causes the counter to return a date code for the last firmware revision as a 4-digit ASCII string.

3-335. SER?: Send Serial Number

SER? →

This query is intended for Automatic Test Equipment (ATE) compatibility. The counter cannot return its actual serial number. Instead, the counter returns a number in the correct format, as shown below:

ddddA00000 <CR> <LF>

- where “dddd” is the firmware revision date, “A” is the country of origin (A = USA), and the number is zero.

3-336. REF?: Send Timebase Reference Status

REF? →

This query causes the instrument to return its reference status: internal or external. The “REF?” query is most useful as a check that the instrument is properly connected. If an external reference is connected, the counter returns “EXT”. If the counter is using its internal 10 MHz reference, the string returned is “INT”.

3-337. OVEN?: Send Oven Status

OVEN? →

This query causes the instrument to return its oven status: warm (if ready) or cold. If neither of the oven oscillator options (Option 001 or 010) is installed, the data message returned is always “WARM”.

Oven status should be checked to ensure that valid measurements may be made when an oven oscillator is installed. Just after ac power is applied to the counter, the oven is cold, and the “OVEN?” query will cause the counter to return “COLD”. After the oven is stabilized at its correct temperature, the data returned will be “WARM”.



3-338. HP-IB DATA OUTPUT

3-339. Frequency Measurements

3-340. The counter, if not in HOLD, continuously makes measurements. At the end of each measurement cycle, the HP-IB status is checked and, if the counter is addressed to talk, the latest measurement is sent to the interface. After the next measurement cycle, the previously sent measurement will be overwritten if it has not been read by a controller, or otherwise handshaken onto the bus. If the counter is not addressed to talk, no measurements are sent to the interface.

3-341. When the counter is in HOLD, no measurement is made until a trigger is received. After the trigger, a single measurement will be made. This result is then sent to the interface if addressed to talk. While waiting for the next trigger, the counter continuously checks for being addressed to talk and, if addressed, sends the last measurement to the interface. Multiple reads of the counter by the controller without intermediate triggers will return the same frequency.

3-342. To read a measurement into an HP-85, execute the statement "ENTER 714; F". This statement will read the measurement, and convert the frequency output format into the HP-85's internal numeric format. To preserve the counter format, read the measurement into a string: "ENTER 714; F\$".

3-343. DUMP mode measurements use the same output method as normal frequency measurements, except for two differences: the output format is different (7 characters, and EOI is sent with the last byte), and the counter cannot be in HOLD.

3-344. Diagnostic Results

3-345. Diagnostics behave similarly to measurements in that the diagnostics continuously cycle. The data is sent to the counter's interface at the end of a cycle after a "DIAG?" query, in a "wait until addressed" mode. In this mode, the interface holds the data until it is read by the controller, and will not allow the data to be overwritten by frequency measurements. The interface receives the data regardless of whether the counter is addressed to talk or not. A "DIAG?" query must be sent to the counter for each result desired. Diagnostic failure results are sent back in the same way as diagnostic pass results.

3-346. Other Outputs

3-347. All other outputs must be requested by the controller through a query command. The data is sent to the counter's interface immediately, in a "wait until addressed" mode, as previously described. Refer to the syntax for the individual query commands, beginning at paragraph 3-328, for details on output format and content.



3-348. Numeric Output Format

3-349. Frequency measurements (except "DUMP" mode measurements), keycodes ("KEY?"), and error numbers ("ERR?") are output to the HP-IB in scientific notation. The output data always contains 24 characters which are arranged in the following format:

- Variable number of spaces (N spaces) (at least 1 space)
- Sign: "-" if negative, or <sp> if positive
- One digit
- Decimal point
- Variable number of digits (K digits)
- E ± sign
- Two exponent digits
- Carriage return
- Line feed

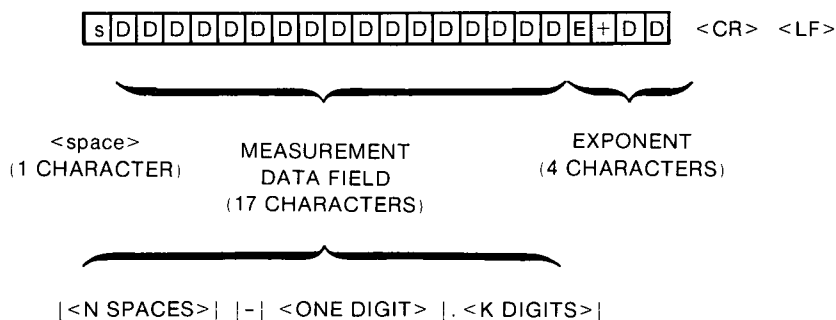

The decimal point is omitted if it is the last character preceding the exponent "E" in the output string. The first digit will be zero only if the data output is zero.

The sign is "-" or <space> (implied positive), and is placed immediately to the left of the first digit of the mantissa. The sign may be preceded by blanks to make the total string length constant. The returned frequency returns all significant digits. The number of significant digits depends on the resolution to which the measurement was made.

3-350. **MEASUREMENT DATA FIELD.** The data field consists of 17 characters. The number begins with the sign, followed by the digits in descending order of significance. The number is right-justified within the data field. To keep the number of characters constant within the total string, spaces are inserted preceding the sign.

3-351. **EXPONENT.** Preceded by an "E" and the sign (±), the exponent will always be two digits. For frequency measurements, Hertz units are implied.

3-352. **TYPICAL OUTPUT STRINGS.** The following string illustrates the typical output for an "AUTO" measurement of 19.412 530 789 GHz. The output data is always followed by a carriage return <CR>, and a line feed <LF>, as shown below (Note: quotes are not sent over the bus):

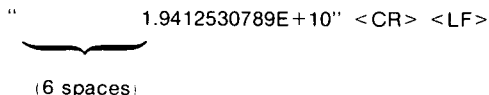



3-353. If there is an overflow (the math result is out of bounds), or the counter cannot acquire the input signal, the following output is sent over the HP-IB (refer to paragraph 3-324, Dump Mode, for exception):

" 1E+38" <CR> <LF>
(17 spaces)

3-354. Query Output Formats

3-355. For details of the output formats for the various query commands, refer to the Command Syntax Descriptions beginning at paragraph 3-328.

3-356. ERROR HANDLING

3-357. Certain conditions will produce an error in the HP 5350A/51A/52A. Refer to paragraph 3-155 for further details on error messages.

3-358. Errors produce a static error condition. Normal operation is suspended until the error is cleared. In the error state, the instrument processes all HP-IB commands. Errors are cleared by a Device Clear, Selected Device Clear, the "INIT", "RESET", and "CLR" commands, and the RESET/LOCAL key. (Pressing the RESET/LOCAL key will also return the counter to local operation.) Error messages are listed in *Table 3-5*.

3-359. Error numbers can be read via the bus by sending the "ERR?" command. When the "ERR?" command is received, the instrument will send the error message to the controller. The instrument will remain in the error state. For example, the following command strings are required to transmit the error number to the HP-85 display:

```
OUTPUT 714; "ERR?"  
ENTER 714;X$  
DISP X$
```

3-360. The Status Byte (refer to paragraph 3-261) contains an error bit to flag an error condition. When an error condition occurs, the set flag reflects the message displayed by the counter. The error flag is cleared when the error is cleared as described previously. Note that there is a slight delay between the "INIT" command and the clearing of the Status Byte flag. If a serial poll is performed during this time, the Status Byte flag will still show an error.

3-361. PROGRAMMING EXAMPLES

3-362. The following program examples are illustrative of HP 5350A/51A/52A programming. The HP 9836 controller is used and the examples are shown in Series 200 BASIC and also in HPL.



BASIC

HPL

100	DIM F\$(24)	0:	dim F\$(26)
110	REMOTE 714	1:	rem 714
120	OUTPUT 714;"SAMPLE,FAST"	2:	wrt 714,"sample,fast"
130	FOR K=1 TO 10	3:	for K=1 to 10
140	ENTER 714;F\$	4:	red 714,F\$
150	PRINT K;F\$	5:	prt K,F\$
160	NEXT K	6:	next K
170	LOCAL 714	7:	lcl 714
180	END	8:	end
			*3082

This program sets the 5350A/51A/52A for remote operation, and sets the sample rate to take measurements as fast as possible. Ten measurements are taken; after each measurement, the measurement data is entered into a string and the string content is printed out by the controller. After the 10 measurements have been taken, the counter is returned to local operation.

10	DIM F\$(24)	0:	dim F\$(26)
20	REMOTE 714	1:	rem 714
30	OUTPUT 714;"SAMPLE,HOLD"	2:	wrt 714,"sample,hold"
40	FOR K=1 TO 10	3:	for K=1 to 10
50	OUTPUT 714;"TRIGGER"	4:	wrt 714,"trigger"
60	ENTER 714;F\$	5:	red 714,F\$
70	PRINT K;F\$	6:	prt K,F\$
80	NEXT K	7:	next K
90	LOCAL 714	8:	lcl 714
100	END	9:	end
			*26700

This program sets the 5350A/51A/52A for remote operation, and sets the sample rate to wait indefinitely until triggered. The counter is triggered 10 times; at each measurement, the measurement data is entered into a string, and the string content is printed out by the controller. After 10 triggered measurements, the counter is returned to local operation.

10	DIM D\$(24)	0:	dim D\$(26)
20	REMOTE 714	1:	rem 714
30	OUTPUT 714;"DIAG,10"	2:	wrt 714,"diag,10"
40	OUTPUT 714;"DIAG?"	3:	wrt 714,"diag?"
50	ENTER 714;D\$	4:	red 714,D\$
60	PRINT D\$	5:	prt D\$
70	OUTPUT 714;"DIAG,OFF"	6:	wrt 714,"diag,off"
80	LOCAL 714	7:	lcl 714
90	END	8:	end
			*3717

This program sets the 5350A/51A/52A for remote operation, and turns on Diagnostic 10 (Timebase Verification). The controller sends a query to the counter, and the diagnostic result is entered into a string. The controller prints the string content, turns the diagnostic off, and then returns the counter to local operation.



BASIC

HPL

10	DIM D\$(24)	0:	dim D\$(24)
20	REMOTE 714	1:	rem 714
30	D\$="REMOTE MESSAGE"	2:	"remote message"}D\$
40	OUTPUT 714;"DISPLAY,"&D\$&"	3:	wrt 714,"display,"&D\$&"
50	WAIT 2	4:	wait 2000
60	OUTPUT 714;"DISPLAY,"	5:	wrt 714,"display,"
70	LOCAL 714	6:	lcl 714
80	END	7:	end

*8886

This program sets the 5350A/51A/52A to remote, and sets up a string containing a 14-character message. The controller sends the DISPLAY command to the counter, with the message to be displayed. The message is displayed on the counter's front panel Liquid Crystal Display for two seconds, after which a blank is sent to the counter to clear the display. The counter is then returned to local. Note the use of double and single quotes in the message to be displayed. The counter requires that the data sent with the DISPLAY command be delimited by quotes. In this case, the data (D\$) is delimited by single quotes. In line 40 of the BASIC program (and HPL line 4) three strings are joined (using &) to form the command to the counter: "DISPLAY, 'REMOTE MESSAGE'".

10	Mask=4+2	0:	4+2}M
20	REMOTE 714	1:	rem 714
30	OUTPUT 714;"SRQMASK,";Mask	2:	wrt 714,"srqmask,".M
40	P=SPOLL(714)	3:	rds(714)}P
50	PRINT P	4:	prt P
60	LOCAL 714	5:	lcl 714
70	END	6:	end

*8857

This program assigns a decimal value of 6 (4+2) to the variable "Mask". The 5350A/51A/52A is then set to remote, and the SRQMASK command is sent, along with the decimal value. The value of 4+2 enables the Error bit and the Measurement Complete bit in the status byte as conditions to generate an SRQ, if one or both of the conditions occurs. The controller next takes a serial poll of the counter, and assigns the value of the received status byte to the variable "P". The controller prints the status byte contents, and then returns the counter to local.



BASIC

HPL

10	DIM F\$(100)[7]	0:	dim F\$[100,7]
20	REMOTE 714	1:	fxd 0
30	OUTPUT 714:"MANUAL,4E+9"	2:	rem 714
40	OUTPUT 714:"SAMPLE,FAST"	3:	wrt 714,"manual,4e9"
50	OUTPUT 714:"RESOL,4"	4:	wrt 714,"sample,fast"
60	OUTPUT 714:"OFFSET,OFF"	5:	wrt 714,"resol,4"
70	OUTPUT 714:"SCALE,OFF"	6:	wrt 714,"offset,off"
80	OUTPUT 714:"SMOOTH,OFF"	7:	wrt 714,"scale,off"
90	OUTPUT 714:"DUMP,ON"	8:	wrt 714,"smooth,off"
100	!	9:	wrt 714,"dump,on"
110	FOR K=1 TO 100	10:	%
120	ENTER 714:F\$(K)	11:	for K=1 to 100
130	NEXT K	12:	red 714,F\$(K)
140	!	13:	next K
150	OUTPUT 714:"DUMP,OFF"	14:	%
160	FOR K=1 TO 100	15:	wrt 714,"dump,off"
170	F=VAL(F\$(K))*10000	16:	for K=1 to 100
180	PRINT K,F;"Hz"	17:	val(F\$(K))*10000}F
190	NEXT K	18:	prt K,"",F,"Hz"
200	!	19:	next K
210	LOCAL 714	20:	%
220	END	21:	lcl 714
		22:	end
			*5798

This program sets the 5350A/51A/52A to remote, followed by all the commands required to prepare the counter for DUMP mode: Manual measurement mode (with a chosen center frequency of 4 GHz), sample rate set for the fastest possible measurements, 10 kHz resolution, and all Math functions off. The DUMP mode is then enabled. The controller enters the data from a series of measurements into 100 strings, after which the DUMP mode is turned off. The content of each string is converted into a numeric value, multiplied by 10,000, and printed out by the controller, in Hz units. Finally, the counter is returned to local operation.



BASIC

```
10 DIM F$(24)
20 REMOTE 714
30 OUTPUT 714;"SAMPLE,HOLD"
40 OUTPUT 714;"SRQMASK,2"
50 ON INTR 7 CALL Display
60 ENABLE INTR 7;2
70 !
80 OUTPUT 714;"TRIGGER"
90 FOR K=1 TO 20
100   WAIT .10
110  NEXT K
120  LOCAL 714
130  END
140  !
150  SUB Display
160  S=SPOLL(714)
170  PRINT "STATUS = ";S
180  ENTER 714;F$
190  PRINT "Measured: ";F$;" Hz"
200  ENABLE INTR 7;2
210  SUBEXIT
220  SUBEND
```

HPL

```
0: dim F$(26)
1: rem 714
2: wrt 714."sample,hold"
3: wrt 714,"srqmask.2"
4: oni 7,"Display"
5: eir 7,128
6: %
7: wrt 714,"trigger"
8: for K=1 to 20
9: wait 100
10: next K
11: lcl 714
12: gto "exit"
13: %
14: "Display":%
15: rds(714)}S
16: prt "STATUS = ",S
17: red 714,F$
18: prt "Measured:",F$."Hz"
19: eir 7,128
20: iret
21: "exit":end
*10580
```

This program illustrates the use of interrupts to detect the end of a measurement. The 5350A/51A/52A sample rate is set to HOLD so that a triggered measurement may be made. The Measurement Complete bit of the service request mask is enabled as a condition to cause a service request. The controller is set up to call a subroutine ("Display") to handle the service request interrupt when it occurs. The counter is triggered and begins a measurement. A two second wait loop is executed during which the counter completes the measurement and causes an SRQ interrupt. The Display subroutine is called; this subroutine proceeds to read and print the serial poll status byte and the just completed measurement. The Measurement Complete bit in the status byte is automatically cleared after the serial poll. The subroutine sets up the controller to accept interrupts, and then returns to the main program. When the wait loop is finished, the counter is returned to local.

SECTION IV PERFORMANCE TESTS

4-1. INTRODUCTION

4-2. This section contains procedures for testing the electrical performance of the HP 5350A, 5351A and 5352A Microwave Frequency Counters, using the specifications listed in *Table 1-1* as performance standards. All test procedures in this section apply to all three models unless otherwise indicated. Specifications which apply only to an individual model are indicated in the following procedures by being enclosed in brackets, [].

4-3. OPERATION VERIFICATION

4-4. The Operation Verification procedure, beginning at paragraph 4-17, is an abbreviated series of tests that may be performed to give a high degree of confidence that the instrument is operating properly without performing the complete Performance Test. An Operation Verification should be useful for incoming Quality Assurance, routine maintenance, and after instrument repair.

4-5. PERFORMANCE TEST

4-6. The complete Performance Test procedures begin at paragraph 4-30. All tests can be performed without access to the inside of the instrument.

4-7. HP-IB VERIFICATION

4-8. An HP-IB verification program, described in paragraph 4-24, exercises the instrument through the majority of its command set via the HP-IB interface. The program is written for an HP-85B as the controller. If the instrument successfully completes all phases of the verification program, there is a very high probability that the HP-IB interface and the counter are working properly. The HP-IB program is available on a cassette, HP Part No. 59300-10002 (Revision G or later).

4-9. EQUIPMENT REQUIRED

4-10. The equipment required for all test procedures in this section is listed in *Table 1-5*. Any equipment that satisfies the required characteristics given in the table may be substituted for the recommended models.

4-11. CALIBRATION CYCLE

4-12. The HP 5350A/51A/52A requires periodic verification of operation. Depending on the use and environmental conditions, the counter should be checked using the Operation Verification procedure at least once every year. A full calibration procedure, including adjustments and a full Performance Test, should be performed at least once every 6 months for instruments equipped with the standard TCXO timebase, at least once a year for instruments equipped with the Option 001 Oven Oscillator Timebase, and once every 5 years for instruments equipped with the Option 010 High Stability Timebase, in order to maintain kHz accuracy of the HP 5350A/51A/52A.

4-13. TEST RECORD

4-14. Results of the operation verification should be recorded on a copy of the Operation Verification Record, *Table 4-3*, located at the end of the procedure. Results of the Performance Tests should be recorded on a copy of the Performance Test Record, *Table 4-4*, located at the end of this section.

4-15. OPTION TEST SPECIFICATIONS

4-16. The Operation Verification and Performance Tests described in this section are intended for testing of the standard HP 5350A/51A/52A. If Option 002 (Rear Panel Inputs) or Option 006 (Limiter) is installed in the 5350A or 5351A, the sensitivity specifications of the counter will be different from the standard instrument. An HP 5350A or 5351A equipped with either, or both, options should be tested using the same procedures as for the standard instrument, using the option specifications described in Section I as performance standards. Refer to *Table 1-1, Specifications*, and Section III, paragraphs 3-47 and 3-49, for information on Option 002 and 006 specifications.

4-17. OPERATION VERIFICATION PROCEDURE

4-18. Power-Up Self Test

- a. Before connecting the power cord and switching on the instrument, be sure that the line voltage selector is properly set, the correct fuse is installed, and that all safety precautions have been observed.
- b. Set the POWER switch to the ON position and verify the Power-Up Self Test routine, as follows:
 1. Immediately after switching the power on, the counter performs a display test in which all segments of the liquid crystal display are turned on. The display should remain in this state for about three seconds. Check that no segments are missing.
 2. If any of the internal tests fail, the results of the first test failing will be displayed after the display test. Pressing the RESET/LOCAL key will display the next test, if any, failing. When all failing tests have been displayed, the HP-IB address will be displayed for about two seconds. If all tests pass, the HP-IB address will be displayed immediately after the display test.
 3. After the HP-IB address is displayed, the counter should go into the measurement mode last selected (if the counter had previously been left in Standby), or into the Auto mode with FM Rate Tolerance set to NORMAL (if ac power had previously been disconnected from the counter).
 4. If a FAIL message is displayed during the Power-Up Self Test, refer to troubleshooting procedures in Section VIII, Service, for information about specific diagnostic failures.
- c. Enter results of the Power-Up Self Test on the Operation Verification Record (*Table 4-3*).

4-19. INPUT 2, Gating and Counting Check

- a. Set the counter to the INPUT 2, 50 Ω impedance mode by pressing the 50 Ω key.
- b. Connect the rear panel 10MHZ OUT BNC to the front panel INPUT 2. Verify that the instrument displays: 10 000 000 (± 1 Hz).
- c. Enter results on the Operation Verification Record.

4-20. INPUT 2, 10 Hz-525 MHz Input Sensitivity Test

4-21. The following test is in two parts, Setup 1 for 50 MHz to 525 MHz, and Setup 2 for 10 Hz to 20 MHz.

Specification: 50 Ω : 10 MHz to 525 MHz, 25 mV rms
1M Ω : 10 Hz to 80 MHz, 25 mV rms

Description: The counter is set to the 10 MHz-525 MHz range, 50 Ω impedance, and a 25 mV rms (-19.3 dBm) signal is applied to INPUT 2. The test generator is set to selected frequencies and the 5350A/51A/52A is checked for proper counting. The counter is next set for 1M Ω impedance, a 25 mV rms (-19.3 dBm) 80 MHz signal is applied to INPUT 2 through a 50 Ω feedthrough, and the counter is checked for proper counting. The test setup is changed to Setup 2 to test the 10 Hz-20 MHz range.

Setup 1: INPUT 2, 50 MHz-525 MHz

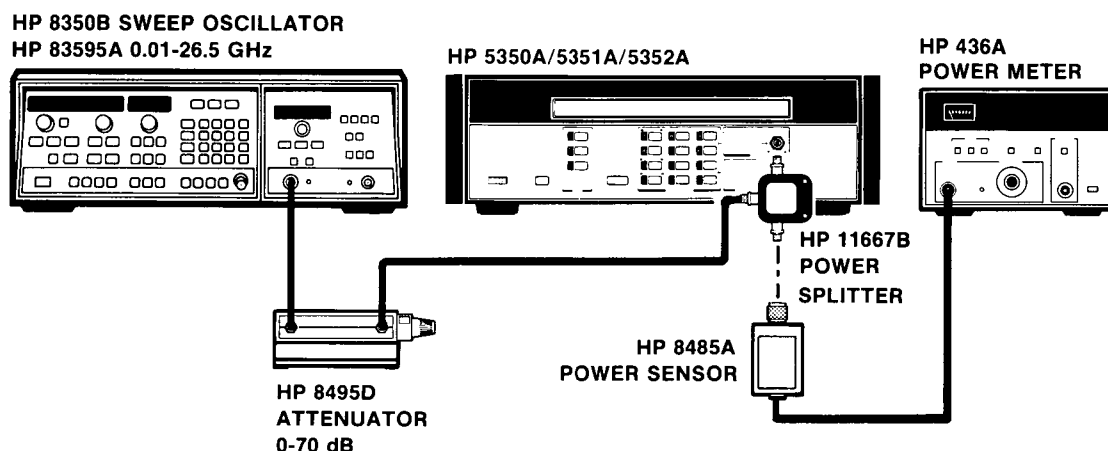

- Set the counter to the 10 MHz-525 MHz range, 50 Ω impedance, by pressing the 50 Ω key.
- Set the 8350B to 50 MHz, and the 83595A and 8495D for an output level of -19.3 dBm (25 mV rms) as measured on the 436A Power Meter. Measure actual sensitivity and verify that the 5350A/51A/52A counts properly at 50 MHz, 100 MHz, 250 MHz, and 525 MHz. (Note that exact frequencies may not be achieved due to the frequency stability characteristics of the 8350B source.) Enter the results in the Operation Verification Record (Table 4-3).
- Insert a 50 Ω feedthrough between the 11667B power splitter and INPUT 2 of the counter. Press the 1M Ω key on the counter to select the 1M Ω impedance, 10 Hz-80 MHz input.
- Set the 8350B to 80 MHz, and set the 83595A for a level of 25 mV rms (-19.3 dBm) as measured on the 436A Power Meter.
- Verify that the 5350A/51A/52A counts properly at 80 MHz at 25 mV rms, and enter the result in the Operation Verification Record.

Setup 2: INPUT 2, 10 Hz-20 MHz

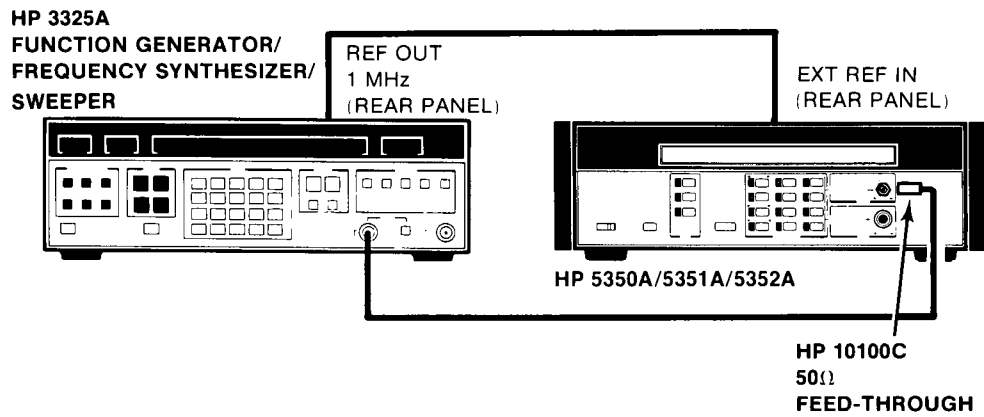

- a. 5350A/51A/52A settings are the same as in the 80 MHz test (INPUT 2, 1M Ω).
- b. Connect the 3325A to INPUT 2 of the counter via a 50 Ω feedthrough. Set the 3325A for an output of 25 mV rms (-19.3 dBm) at 10 Hz.
- c. Verify that the counter counts properly at 10 Hz, 50 kHz, 1 MHz, 10 MHz, and 20 MHz. Enter results in the Operation Verification Record.

4-22. INPUT 1, 500 MHz-20 GHz [26.5 GHz, 40 GHz] Input Sensitivity Test

4-23. The following test is in two parts, Setup 1 for 500 MHz to 20 [26.5] GHz, and Setup 2 for 26.5 GHz to 40 GHz [5352A only].

Specifications:	5350A sensitivity	=	-25 dBm, 500 MHz-12.4 GHz
		=	-20 dBm, 12.4 GHz-20 GHz
	5351A sensitivity	=	-25 dBm, 500 MHz-12.4 GHz
		=	-20 dBm, 12.4 GHz-20 GHz
		=	-15 dBm, 20 GHz-26.5 GHz
	5352A sensitivity	=	-25 dBm, 500 MHz-26.5 GHz
		=	$0.741 \times \text{freq. in GHz} - 44.6 \text{ dBm}$, for frequencies greater than 26.5 GHz.
			(-15 dBm at 40 GHz)

Description: The counter is set to the 500 MHz-20 GHz [26.5 GHz, 40 GHz] range and the appropriate input signal is applied to INPUT 1. The generator is set to selected frequencies and levels appropriate to the model being tested, and the actual sensitivity of the HP 5350A/51A/52A is measured up to 20 GHz [26.5 GHz, 5351A/5352A]. Setup 2 is used to measure the actual sensitivity of the 5352A at selected frequencies up to 40 GHz.

Setup: 500 MHz-20 GHz [26.5 GHz]

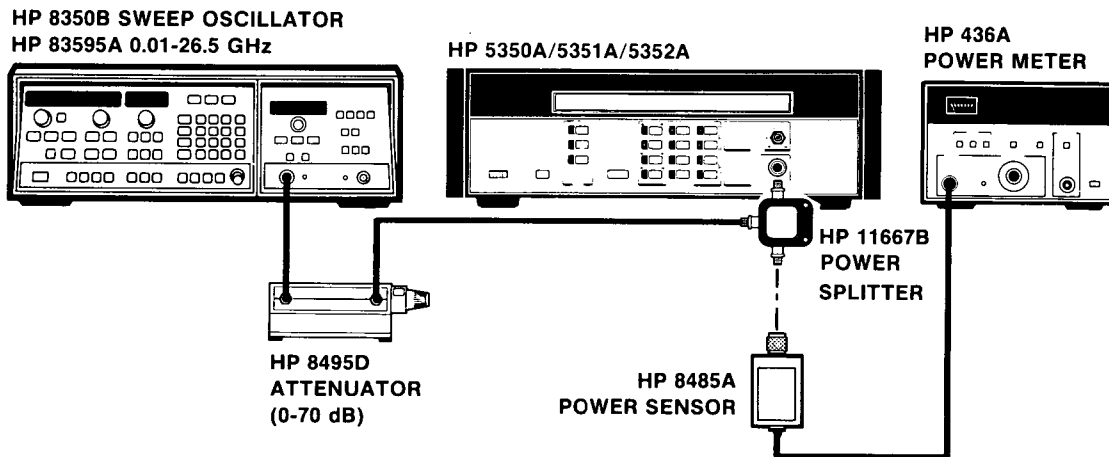

- Set the counter to INPUT 1, Automatic mode by pressing the AUTO key.
- Connect the equipment as shown in Setup 1.
- Set the 8350B to 500 MHz, and set the 83595A and 8495D for -25 dBm, as measured on the 436A.
- Measure the actual sensitivity at 500 MHz, 1 GHz, 5 GHz, and 12.4 GHz. (Verify the signal level with the 436A Power Meter at each of these frequencies.) Enter the actual sensitivity result in the Operation Verification Record.
- Set the 8350B to 18 GHz. If a 5350A or 5351A is being tested, set the 83595A and 8495D for -20 dBm [the level should remain at -25 dBm for the 5352A] as measured on the 436A.



- f. Measure the actual sensitivity at 18 GHz and 20 GHz. (Verify the signal level with the 436A Power Meter at each of these frequencies.) Enter the actual sensitivity result in the Operation Verification Record.
- g. If a 5351A is being tested, set the 83595A and 8495D for -15 dBm at 22 GHz. Measure the actual sensitivity at 22 GHz and 26.5 GHz. Enter the actual sensitivity result in the Operation Verification Record.
- h. If a 5352A is being tested, leave the 83595A and 8495D set to -25 dBm at 22 GHz. Measure the actual sensitivity at 22 GHz and 26.5 GHz. Enter the actual sensitivity result in the Operation Verification Record.

Setup 2: 26.5 GHz-40 GHz [5352A]

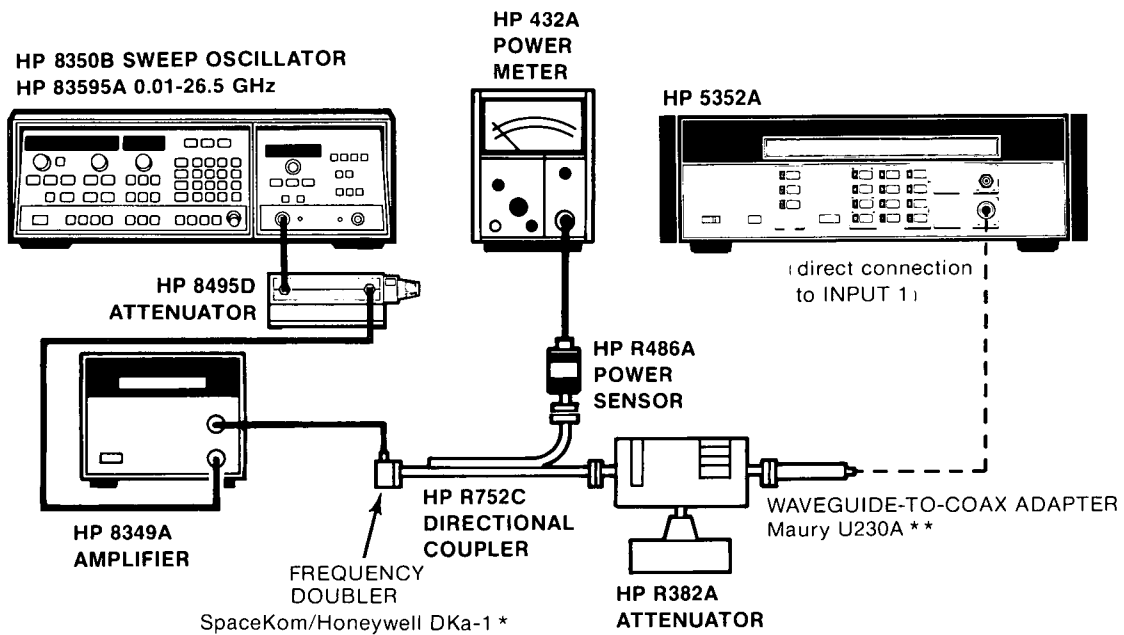

* Available from: Honeywell, Inc., Santa Barbara Microwave Division, 214 E. Gutierrez St., Santa Barbara, CA 93101.

** Available from: Maury Microwave Corporation, 8610 Helms Avenue, Cucamonga, CA 91730.

- a. Set the 5352A to INPUT 1, Automatic mode by pressing the AUTO key.
- b. Connect the equipment as shown in Setup 2.

CAUTION

To prevent damage to the frequency doubler from excessive input levels, be sure that the 8349A Amplifier is turned off before turning on the signal source, and that the output level of the source is set to approximately -20 dBm before the 8349A Amplifier is turned on.

- c. Measure the actual sensitivity at 26.5 GHz, 30 GHz, 34 GHz, and 40 GHz, as follows:
 1. Set the 8350B to 13.25 GHz, and set the 83595A and 8495D for a $+15$ dBm output from the 8349A Amplifier (as indicated on the 8349A front panel display).



2. Add attenuation by adjusting the R382A Precision Attenuator until the counter stops measuring, then decrease the attenuation until the counter just begins to measure the input.
 3. Note the doubled frequency (26.5 GHz) power reading on the 432A, add +10 dB to the reading, and subtract the value of the R382A attenuator setting to obtain the sensitivity level of the counter.
 4. Repeat the above steps at 30 GHz, 34 GHz, and 40 GHz (15, 17, and 20 GHz input to the doubler, respectively).
- d. Enter the actual sensitivity result in the Operation Verification Record.

4-24. HP-IB VERIFICATION

4-25. The HP-85 program listed in *Table 4-1* exercises the HP 5350A/51A/52A through various operating modes via the counter's HP-IB interface. If the counter successfully completes all phases of the verification program, there is a high probability that the HP-IB interface (A11 Assembly) is operating correctly. This program is not intended to be an automated test system for operation verification of the entire counter, but rather an aid to verify that the HP-IB interface is handshaking properly, sending valid data to the controller, and controlling the counter properly. If the HP 5350A/51A/52A does not respond as described, refer to A11 HP-IB Interface Assembly troubleshooting in Section VIII, Service.

4-26. To perform the verification, set up the HP 5350A/51A/52A, HP-85B, and signal source as shown below. The program will function with any valid HP-IB address set for the counter.

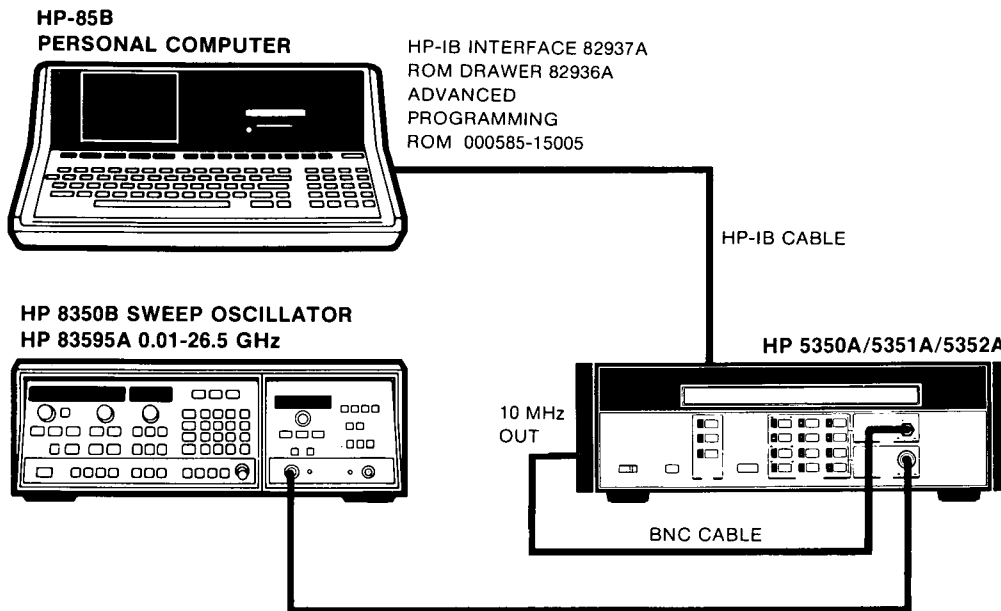

NOTE

If using an HP-85A, a Mass Storage ROM (HP P/N 00085-15001) and I/O ROM (HP P/N 00085-15003) will be required to run the verification program.



4-27. The program listed in *Table 4-1* may be keyed into the HP-85B, or may be loaded from an HP-IB Verification Cassette, HP P/N 59300-10002, (Revision G or later). To run the program on the cassette, insert the cassette into the HP-85B, load the program "5350/1", and press RUN.

4-28. The program goes through 16 checkpoints, including a test to verify remote response at all legal addresses (Checkpoint 16). At the conclusion of each checkpoint, the operator is requested to enter the results of the current checkpoint. These results are stored and can be printed upon completion of the program. *Table 4-2* is a sample printout of the results of the HP-IB Verification program. The printed listing of results should be attached to the Operation Verification Record (*Table 4-3*).

4-29. Various checkpoints throughout the program ask the operator to verify that the counter's GATE annunciator is on, as well as other annunciators. Note that if a signal is present at the appropriate input, the GATE annunciator should be flashing at a rate proportional to the sample rate.



Table 4-1. HP-85 Program Listing

```

5 ! ***HP 5350/5351/5352**
10 ! HP-IB OPERATION
15 ! VERIFICATION PROGRAM
20 !
25 ! BJC, SM
30 ! DATE: 8 MARCH 1985
35 ! REVISION B
40 !
45 ! This program exercises
50 ! 5350/5351/5352 through the
55 ! majority of its command
60 ! code set via HP-IB. The
65 ! program consists of 16
70 ! checkpoints, and provides
75 ! the user with the ability
80 ! to execute and repeat
85 ! these tests in any order.
90 ! Also provided are options
95 ! to print the checkpoint
100 ! summary and results. The
105 ! program relies on
110 ! subroutines in addition
115 ! to arrays and simple
120 ! variables.
125 !
130 ! Dimension and initialize
135 ! string variable arrays.
140 PRINTER IS 2
145 OPTION BASE 1
150 DIM A$(32),B$(32),D$(24),F$(32),G$(32)
155 DIM H$(32),I$(32),N$(7),R$(15),R(16)
160 DIM S$(68),D(30),D1(30)
165 D=0
170 T=0
175 ! VARIABLE TABLE
180 ! A=Address of counter
185 ! C=CRT(1) or PRINTER(2)
190 ! D=Desired checkpoint
195 ! T=Test#
200 ! I=Do Loop Index
205 ! M=Measmt data (real)
210 ! M1=Measmt data (real)
215 ! K=Address failure counter
220 ! J=Address pass counter
225 ! D(30)=Failed address array
230 ! D1(30)=Passed address array
235 ! R(16)=Array to store test results
240 AS="Press CONT to perform test."
245 BS="Press CONT when ready."
250 ! D$= ASCII data
255 N$="" ! ID of counter
260 F$="Press CONT for next display."
265 G$=" CHECKPOINT "
270 HS="*****"
275 ! R$="PASS" or "FAIL"
280 ! S$=Front panel set-up data
285 !
290 ! Initialize test
295 ! results array
300 FOR I=1 TO 16
305 R(I)=2
310 NEXT I
315 CRT IS 1
320 C=1
325 ENABLE KBD 1+32
330 !
335 ! DISPLAY TITLE, CHECKPOINT LIST AND
340 ! SETUP INSTRUCTIONS
345 CLEAR
350 DISP USING "5/,"
355 DISP H$
360 DISP
365 DISP "5350/5351/5352 HP-IB OPERATION "
370 DISP " VERIFICATION PROGRAM"
375 DISP
380 DISP H$
385 DISP
390 WAIT 2500
395 CLEAR
400 DISP USING "5/,"
405 DISP H$
410 DISP
415 DISP H$
420 DISP
425 DISP " CHECKPOINT SUMMARY"
430 DISP
435 DISP H$
440 DISP
445 ! IF PRINTER(2) THEN SKIP
450 ! WAIT AND CLEAR
455 IF C=2 THEN 470
460 WAIT 2000
465 CLEAR
470 DISP " 1 Remote,Local Lockout, Local"
475 DISP " 2 Self Check ('TEST?')"
480 DISP " 3 'DISPLAY'"
485 DISP " 4 'INIT' & 'RESET'"
490 DISP " 5 'REF' & 'OVEN'"
495 DISP " 6 'ERR?'"
500 DISP " 7 'SET' & 'SET?'"
505 DISP " 8 'LOWZ' & 'HIGHZ'"
510 DISP " 9 'SAMPLE' & 'TRIGGER'"
515 DISP " 10 'RESOL' & 'HIRESOL'"
520 DISP " 11 'OFFSET', 'SCALE' & 'SMOOTH'"
525 DISP " 12 'AUTO' & 'MANUAL'"
530 DISP " 13 'FMRATE'"
535 DISP " 14 'SROMASK'"
540 DISP " 15 'DUMP'"
545 WAIT 3000
550 CLEAR
555 DISP " 16 CHECK ALL ADDRESSES"
560 ! IF PRINTING,CONTINUE
565 IF C=2 THEN GOTO 665
570 DISP
575 DISP F$
580 PAUSE
585 CLEAR
590 DISP "Would you like a printed version"
595 DISP "of the checkpoint summary?"
600 DISP USING "3/,"
605 DISP "YES-Press K1 to receive a"
610 DISP "printed version."
615 DISP
620 DISP "NO-Press K4 to proceed"
625 ON KEY# 1,"YES" GOTO 645
630 ON KEY# 4," NO" GOTO 680
635 KEY LABEL
640 GOTO 640
645 CLEAR ! YES PRINTOUT
650 CRT IS 2
655 C=2
660 GOTO 405 ! GO BACK AND PRINT
665 DISP USING "5/,"
670 CRT IS 1
675 C=1
680 CLEAR ! NO PRINTOUT
685 DISP "The HP 85B should have an "
690 DISP "Advanced Prgrm Rom in its ROM"
695 DISP "Drawer and an 82937A HP-IB"
700 DISP "Interface Card/Cable."
705 DISP "Connect the HP-IB Interface to"
710 DISP "the rear panel of the HP 5350"
715 DISP "5351, or 5352 and power-up the"
720 DISP "instrument. A source capable"

```

Table 4-1. HP-85 Program Listing (Continued)



```

725 DISP "of outputting 1 GHz from -10"
730 DISP "dBm to +10 dBm will also be"
735 DISP "needed to complete this"
740 DISP "verification."
745 WAIT 10000
750 CLEAR
755 DISP
760 DISP "Consult the HP 5350/5351/5352"
765 DISP "Operating and Service Manual"
770 DISP "for additional information."
775 DISP
780 DISP B$
785 PAUSE
790 !
795 ! SEARCH FOR 5350/5351/5352
800 ! ADDRESS
805 CLEAR
810 DISP USING "3/."
815 DISP "Searching for counter address..."
820 SET TIMEOUT 7:1000
825 ON TIMEOUT 7 GOTO 890
830 FOR A=700 TO 730
835 ! 721 = ADDRESS OF CONTROLLER
840 IF A=721 THEN 900
845 REMOTE A
850 OUTPUT A : "ID?"
855 ENTER A : N$
860 IF N$="HP5350A" THEN 950
865 IF N$="HP5351A" THEN 950
870 IF N$="HP5350M" THEN 950
875 IF N$="HP5351M" THEN 950
880 IF N$="HP5352A" THEN 950
885 IF N$="HP5352M" THEN 950
890 ABORTIO 7
895 CLEAR A
900 NEXT A
905 BEEP 250.25
910 WAIT .1
915 BEEP 250.25
920 DISP
925 DISP "Address not found."
930 DISP
935 DISP B$
940 PAUSE
945 GOTO 805 ! TRY AGAIN
950 DISP
955 DISP N$:" found at address":A: "."
960 BEEP 250.25
965 WAIT 250
970 BEEP 250.25
975 WAIT 2000
980 SET TIMEOUT 7:0
985 ! IF CKPT 16 THEN RETURN TO
990 ! IT
995 IF T=16 THEN GOTO 6080
1000 GOSUB 6485 ! CHOOSE 1ST CHKPT
1005 GOTO 6425 ! GOTO CHECKPOINT
1010 !
1015 ! CHECKPOINT 1
1020 T=1
1025 I$="REMOTE, LOCAL LOCKOUT AND LOCAL"
1030 GOSUB 6085 ! DISPLAY TITLE
1035 DISP
1040 DISP "Checkpoint 1 tests the"
1045 DISP "REMOTE, LOCAL LOCKOUT,"
1050 DISP "and LOCAL HP-IB commands."
1055 DISP "Each command will be"
1060 DISP "programmed and the operator"
1065 DISP "will be prompted as to what"
1070 DISP "conditions should be verified."
1075 DISP
1080 DISP B$
1085 PAUSE
1090 CLEAR
1095 LOCAL A
1100 REMOTE A
1105 OUTPUT A : "INIT"
1110 DISP
1115 DISP " REMOTE"
1120 DISP
1125 DISP "Verify that the REM.LSN.FM NORM"
1130 DISP "and AUTO annunciators are on."
1135 DISP
1140 DISP B$
1145 PAUSE
1150 CLEAR
1155 DISP
1160 DISP " LOCAL LOCKOUT"
1165 DISP
1170 DISP "Verify that pressing any of the"
1175 DISP "front panel keys other than"
1180 DISP "POWER will not affect the"
1185 DISP N$:"."
1190 DISP USING "2/."
1195 DISP B$
1200 LOCAL LOCKOUT 7
1205 PAUSE
1210 CLEAR
1215 DISP
1220 DISP " LOCAL"
1225 DISP
1230 DISP "Verify that the REM annunciator"
1235 DISP "is no longer on, and the ":N$"
1240 DISP "responds to front panel entries."
1245 LOCAL 7
1250 DISP USING "2/."
1255 DISP B$
1260 PAUSE
1265 REMOTE A
1270 GOTO 6170 ! RECORD RESULTS
1275 !
1280 ! CHECKPOINT 2
1285 T=2
1290 I$=" SELF CHECK ('TEST?')"
1295 GOSUB 6085 ! DISPLAY TITLE
1300 DISP
1305 DISP "Checkpoint 2 tests the 'TEST?'"
1310 DISP "HP-IB command. The results of"
1315 DISP "the SELF CHECK will be sent over"
1320 DISP "the bus and displayed on the"
1325 DISP "controller CRT."
1330 DISP
1335 DISP B$
1340 PAUSE
1345 CLEAR
1350 REMOTE A
1355 OUTPUT A : "INIT"
1360 OUTPUT A : "TEST?"
1365 ENTER A : D$
1370 DISP "The results of SELF CHECK are:"
1375 DISP
1380 DISP " :D$"
1385 DISP
1390 IF D$[1,4]="PASS" THEN 1430
1395 DISP "The ":N$:" failed the SELF"
1400 DISP "CHECK. It is recommended that"
1405 DISP "the fault on the ":D$[18,19]:" or"
1410 DISP "associated assemblies be"
1415 DISP "corrected before continuing with"
1420 DISP "the HP-IB verification."
1425 DISP

```



Table 4-1. HP-85 Program Listing (Continued)

```

1430 DISP "Press CONT to record the results"
1435 PAUSE
1440 GOTO 6170 ! RECORD RESULTS
1445 !
1450 ! CHECKPOINT 3
1455 T=3
1460 I$="      'DISPLAY' COMMAND"
1465 GOSUB 6085 ! DISPLAY TITLE
1470 DISP
1475 DISP "Checkpoint 3 tests the 'DISPLAY'"
1480 DISP "HP-IB command."
1485 DISP
1490 DISP B$
1495 OUTPUT A : "INIT"
1500 PAUSE
1505 CLEAR
1510 DISP USING "3/."
1515 DISP "Verify that the ";N$;" display"
1520 DISP "shows 'HP-IB VERIFICATION'."
1525 OUTPUT A : "DISPLAY," HP-IB VERIFICATION"
1530 DISP
1535 DISP "Press CONT to record results."
1540 PAUSE
1545 OUTPUT A : "DISPLAY,"
1550 GOTO 6170 ! RECORD RESULTS
1555 !
1560 ! CHECKPOINT 4
1565 T=4
1570 I$="      'INIT' & 'RESET'"
1575 GOSUB 6085 ! DISPLAY TITLE
1580 DISP
1585 DISP "Checkpoint 4 tests the 'INIT'"
1590 DISP "and 'RESET' HP-IB commands."
1595 DISP
1600 DISP B$
1605 OUTPUT A : "INIT"
1610 ! SET UP INSTRUMENT STATE
1615 ! TO BE INITIALIZED
1620 OUTPUT A : "OFFSET.ON:SCALE.ON:SMOOTH.ON"
1625 PAUSE
1630 REMOTE A
1635 OUTPUT A : "INIT"
1640 CLEAR
1645 DISP USING "2/." 'INIT'"
1650 DISP "
1655 DISP
1660 DISP "Verify that the REM, LSN, FM"
1665 DISP "NORM and AUTO annunciators are "
1670 DISP "on and that the display shows"
1675 DISP
1680 DISP "      00 000 000 000"
1685 DISP
1690 DISP "without an input."
1695 DISP
1700 DISP B$
1705 PAUSE
1710 ! SET UP ERROR CONDITION
1715 ! MANUAL FREQ 9E+99 IS OUT
1720 ! OF RANGE
1725 OUTPUT A : "MANUAL.9E+99"
1730 CLEAR
1735 DISP USING "3/." 'RESET'"
1740 DISP "
1745 DISP
1750 DISP "Verify that the ";N$[1,7];" exhibits"
1755 DISP
1760 DISP "      OUT OF RANGE 3 ERROR"
1765 DISP
1770 DISP "Press CONT to send the 'RESET'"
1775 DISP "command. Verify that the error"
1780 DISP "message is cleared and the"
1785 DISP "REM,LSN,AUTO,and FM NORM"

1790 DISP "annunciators are on."
1795 PAUSE
1800 OUTPUT A : "RESET"
1805 DISP
1810 DISP "Press CONT to record results."
1815 PAUSE
1820 GOTO 6170 ! RECORD RESULTS
1825 !
1830 ! CHECKPOINT 5
1835 T=5
1840 I$="      'OVEN?' & 'REF?'"
1845 GOSUB 6085 ! DISPLAY TITLE
1850 DISP
1855 DISP "Checkpoint 5 tests the 'OVEN?'"
1860 DISP "and 'REF?' HP-IB commands."
1865 DISP
1870 DISP B$
1875 PAUSE
1880 CLEAR
1885 DISP "      'REF?'"
1890 DISP
1895 DISP "Disconnect the external"
1900 DISP "reference if one is connected."
1905 DISP
1910 DISP B$
1915 PAUSE
1920 REMOTE A
1925 OUTPUT A : "INIT"
1930 ! ENTER THE STATUS OF THE REFERENCE
1935 OUTPUT A : "REF?"
1940 ENTER A ; D$
1945 CLEAR
1950 DISP "      'REF?'"
1955 DISP
1960 DISP "Verify that the OVEN and EXT REF"
1965 DISP "annunciators are off."
1970 DISP
1975 DISP B$
1980 PAUSE
1985 CLEAR
1990 DISP "      'REF?'"
1995 DISP
2000 DISP "The ";N$;" has returned its"
2005 DISP "timebase reference status as "
2010 DISP
2015 DISP "      :D$;"ERNAL"
2020 DISP
2025 IF D$="INT" THEN 2040 ELSE 2030
2030 DISP "RETURNED HP-IB DATA INCORRECT"
2035 DISP
2040 DISP B$
2045 PAUSE
2050 CLEAR
2055 DISP "      'REF?'"
2060 DISP
2065 DISP "Connect an external timebase."
2070 DISP "to the external reference on the"
2075 DISP "rear panel."
2080 DISP
2085 DISP B$
2090 PAUSE
2095 OUTPUT A : "REF?"
2100 ENTER A ; D$
2105 CLEAR
2110 DISP "      'REF?'"
2115 DISP
2120 DISP "Verify that the EXT REF"
2125 DISP "annunciator is on. The ";N$;"
2130 DISP "has returned a reference status"
2135 DISP "of"
2140 DISP
2145 DISP "      :D$;"ERNAL"

```

Table 4-1. HP-85 Program Listing (Continued)



```

2150 DISP
2155 IF D$="EXT" THEN 2165 ELSE 2160
2160 DISP "RETURNED HP-IB DATA INCORRECT"
2165 DISP B$
2170 PAUSE
2175 CLEAR
2180 DISP
2185 DISP
2190 DISP "          'OVEN?'"
2195 DISP
2200 DISP "Disconnect the external timebase"
2205 DISP
2210 DISP "If the ":N$:" has option 001"
2215 DISP "or 010 (ovenized oscillators),"
2220 DISP "the returned status is valid,"
2225 DISP "If the counter does not have"
2230 DISP "these options, the returned"
2235 DISP "status will always be 'WARM'."
2240 DISP
2245 DISP "Press CONT to perform test."
2250 PAUSE
2255 OUTPUT A ;"OVEN?"
2260 ENTER A ; D$
2265 DISP
2270 DISP "The oven status is ":D$
2275 DISP
2280 DISP "Press CONT to record results."
2285 PAUSE
2290 GOTO 6170 ! RECORD RESULTS
2295 !
2300 ! CHECKPOINT 6
2305 T=6
2310 I$="          'ERR?'"
2315 GOSUB 6085 ! DISPLAY TITLE
2320 OUTPUT A ;"INIT"
2325 DISP
2330 DISP "Checkpoint 6 tests the 'ERR?'"
2335 DISP "HP-IB command. An error state"
2340 DISP "will be programmed and the"
2345 DISP "type of error read back to the"
2350 DISP "HP.85."
2355 DISP
2360 DISP B$
2365 PAUSE
2370 ! SET UP ERROR CONDITION
2375 ! 9E99 IS OUT OF RANGE
2380 OUTPUT A ;"MANUAL.9E99"
2385 OUTPUT A ;"ERR?"
2390 ENTER A ; D$
2395 CLEAR
2400 DISP "Verify that the ":N$
2405 DISP "display indicates an error of"
2410 DISP "type 3."
2415 DISP
2420 IF D$[18,18]<>"3" THEN 2425 ELSE 2435
2425 DISP "RETURNED HP-IB DATA INCORRECT."
2430 DISP
2435 DISP "Press CONT to RESET the "
2440 DISP N$;" and record the results."
2445 PAUSE
2450 OUTPUT A ;"RESET"
2455 GOTO 6170 ! RECORD RESULTS
2460 !
2465 ! CHECKPOINT 7
2470 T=7
2475 I$="          'SET' & 'SET?'"
2480 GOSUB 6085 ! DISPLAY TITLE
2485 DISP
2490 DISP "Checkpoint 7 tests the 'SET'"
2495 DISP "and 'SET?' HP-IB commands. A"
2500 DISP "configuration will be"
2505 DISP "programmed and then saved using"
2510 DISP "the 'SET?' command. The ":N$
2515 DISP "will be set to the initial"
2520 DISP "power-on condition and then "
2525 DISP "reprogrammed using the the"
2530 DISP "'SET' command."
2535 DISP
2540 DISP B$
2545 PAUSE
2550 REMOTE A
2555 CLEAR
2560 ! SET UP A CONFIGURATION TO
2565 ! BE SAVED
2570 OUTPUT A ;"INIT"
2575 OUTPUT A ;"SMOOTH.ON:SCALE.1,ON:FMRATE.LOW"
2580 DISP "The front panel set-up to be"
2585 DISP "stored has the SCALE,SMOOTH,"
2590 DISP "REM,LSN,FM LOW and AUTO"
2595 DISP "annunciators on."
2600 DISP
2605 DISP "Verify this set-up and press"
2610 DISP "CONT to store this configuration"
2615 DISP "and initialize the ":N$;".
2620 PAUSE
2625 OUTPUT A ;"SET?"
2630 ! STORE THE SET-UP IN S$
2635 ENTER A ; S$
2640 OUTPUT A ;"INIT"
2645 CLEAR
2650 DISP USING "3/,"
2655 DISP "Verify that the REM,LSN,FM NORM"
2660 DISP "and AUTO annunciators are on."
2665 DISP
2670 DISP B$
2675 PAUSE
2680 OUTPUT A ;"SET,'"":S$;"'"
2685 CLEAR
2690 DISP USING "3/,"
2695 DISP "Verify that the SCALE,SMOOTH,"
2700 DISP "REM,LSN,FM LOW and AUTO"
2705 DISP "annunciators are on again."
2710 DISP
2715 DISP B$
2720 PAUSE
2725 GOTO 6170 ! RECORD RESULTS
2730 !
2735 ! CHECKPOINT 8
2740 T=8
2745 I$="          'LOWZ' & 'HIGHZ'"
2750 GOSUB 6085 ! DISPLAY TITLE
2755 DISP
2760 DISP "Checkpoint 8 tests the 'LOWZ'"
2765 DISP "and 'HIGHZ' HP-IB commands."
2770 DISP "Connect the rear panel 10 MHz"
2775 DISP "OUT to input 2 of the ":N$;".
2780 DISP
2785 DISP B$
2790 PAUSE
2795 REMOTE A
2800 OUTPUT A ;"INIT"
2805 OUTPUT A ;"LOWZ"
2810 ENTER A ; M
2815 CLEAR
2820 DISP
2825 DISP "          'LOWZ'"
2830 DISP
2835 DISP "Verify that the 50 ohm"
2840 DISP "annunciator is on as well as"
2845 DISP "the REM and TLK annunciators."
2850 DISP "The GATE annunciator should be"
2855 DISP "flashing. The display should"
2860 DISP "read:"
2865 DISP

```



Table 4-1. HP-85 Program Listing (Continued)

```

2870 DISP "          10 000 000"
2875 DISP
2880 IF M<>10000000 THEN 2885 ELSE 2900
2885 DISP "RETURNED HP-IB DATA INCORRECT"
2890 DISP
2895 DISP "          ";M
2900 DISP
2905 DISP B$
2910 PAUSE
2915 OUTPUT A ;"HIGHZ"
2920 ENTER A ; M
2925 CLEAR
2930 DISP "          'HIGHZ'"
2935 DISP
2940 DISP "Verify that the REM, TLK, and"
2945 DISP "1 megohm annunciators are"
2950 DISP "on. The GATE annunciator"
2955 DISP "should be flashing. The display"
2960 DISP "should read;"
2965 DISP
2970 DISP "          10 000 000"
2975 DISP
2980 IF M<>10000000 THEN 2985 ELSE 3005
2985 DISP "RETURNED HP-IB DATA INCORRECT"
2990 DISP
2995 DISP "          ";M
3000 DISP
3005 DISP "Press CONT to record results"
3010 PAUSE
3015 GOTO 6170 ! RECORD RESULTS
3020 !
3025 ! CHECKPOINT 9
3030 T=9
3035 I$="          'SAMPLE & TRIGGER'"
3040 GOSUB 6085 ! DISPLAY TITLE
3045 DISP
3050 DISP "Checkpoint 9 tests the"
3055 DISP "'SAMPLE' and 'TRIGGER' HP-IB"
3060 DISP "commands. Connect the rear"
3065 DISP "panel 10 MHz OUT to input 2."
3070 DISP
3075 DISP B$
3080 PAUSE
3085 OUTPUT A ;"INIT"
3090 OUTPUT A ;"SAMPLE,HOLD;HIGHZ"
3095 CLEAR
3100 DISP "Verify that the HOLD,REM,"
3105 DISP "LSN, and 1 megohm annunciators"
3110 DISP "are on. The display should"
3115 DISP "read"
3120 DISP
3125 DISP "          HOLDING---"
3130 DISP
3135 DISP "Press CONT to trigger the"
3140 DISP "counter and take a measurement."
3145 PAUSE
3150 OUTPUT A ;"TRIGGER"
3155 ENTER A ; M
3160 CLEAR
3165 DISP "The measurement should be:"
3170 DISP
3175 DISP "          10 000 000"
3180 DISP
3185 IF M<>10000000 THEN 3190 ELSE 3210
3190 DISP "RETURNED HP-IB DATA INCORRECT"
3195 DISP
3200 DISP "          ";M
3205 DISP
3210 DISP "Press CONT to record results"
3215 PAUSE
3220 GOTO 6170 ! RECORD RESULTS
3225 !
3230 ! CHECKPOINT 10
3235 T=10
3240 I$="          'RESOL' & 'HIRESOL'"
3245 GOSUB 6085 ! DISPLAY TITLE
3250 DISP "Checkpoint 10 tests the 'RESOL'"
3255 DISP "and 'HIRESOL' HP-IB commands."
3260 DISP "Connect the rear panel 10 MHz"
3265 DISP "OUT to Input 2."
3270 DISP
3275 DISP B$
3280 PAUSE
3285 ! START WITH RESOLUTION OF
3290 ! 1 MHZ (RESOL.6)
3295 OUTPUT A ;"INIT"
3300 OUTPUT A ;"HIGHZ;RESOL.6"
3305 CLEAR
3310 DISP "          'RESOL'"
3315 DISP "Verify that the current reading"
3320 DISP "is to 1 MHz resolution."
3325 DISP "Pressing CONT will program"
3330 DISP "another decade of resolution."
3335 DISP
3340 DISP "Continue pressing CONT until"
3345 DISP "the counter displays the"
3350 DISP "measurement with 1 Hz resolution"
3355 DISP
3360 DISP B$
3365 PAUSE
3370 ! LOOP TO INCREASE RESOLUTION
3375 ! BY 1 DECADE WITH EACH CONT
3380 FOR I=5 TO 0 STEP -1
3385 OUTPUT A ;"RESOL.";I
3390 PAUSE
3395 NEXT I
3400 CLEAR
3405 OUTPUT A ;"HIRESOL,ON"
3410 DISP "Verify that the REM,LSN,"
3415 DISP "1 megohm, and HIGH RESOL"
3420 DISP "annunciators are on, the"
3425 DISP "GATE annunciator is flashing"
3430 DISP "and the display reads:"
3435 DISP
3440 DISP "          10 000 000. 0**"
3445 DISP
3450 DISP "Press CONT to record results"
3455 PAUSE
3460 GOTO 6170 ! RECORD RESULTS
3465 !
3470 !
3475 ! CHECKPOINT 11
3480 T=11
3485 I$="          'OFFSET'/'SCALE'/'SMOOTH'"
3490 GOSUB 6085 ! DISPLAY TITLE
3495 DISP
3500 DISP "Checkpoint 11 tests the 'OFFSET'"
3505 DISP "'SCALE', and 'SMOOTH' HP-IB"
3510 DISP "commands. Connect the rear panel"
3515 DISP "10 MHz OUT to Input 2."
3520 DISP
3525 DISP B$
3530 PAUSE
3535 REMOTE A
3540 ! SUBTRACT 5MHZ FROM THE
3545 ! 10 MHZ READING=5MHZ
3550 OUTPUT A ;"INIT"
3555 OUTPUT A ;"OFFSET,-5E6,ON;HIGHZ"
3560 CLEAR
3565 DISP "          'OFFSET'"

```



Table 4-1. HP-85 Program Listing (Continued)

```

3570 DISP "Verify that the OFFSET,REM."
3575 DISP "TLK, and 1 megohm annunciators"
3580 DISP "are on. The GATE light should"
3585 DISP "be flashing. The display"
3590 DISP "should read:"
3595 DISP
3600 DISP "          5 000 000"
3605 ENTER A ; M
3610 ! CHECK MEASUREMENT
3615 IF M<>5000000 THEN 3620 ELSE 3640
3620 DISP
3625 DISP "RETURNED HP-IB DATA IS INCORRECT"
3630 DISP
3635 DISP "          ";M;"Hz"
3640 DISP
3645 DISP B$
3650 PAUSE
3655 ! MULTIPLY THE 10 MHZ
3660 ! READING BY 2=20 MHZ
3665 OUTPUT A ;"OFFSET,OFF;SCALE,2,ON"
3670 CLEAR
3675 DISP "          'SCALE'"
3680 DISP "Verify that the SCALE,REM,"
3685 DISP "TLK, and 1 megohm annunciators"
3690 DISP "are on. The GATE annunciator"
3695 DISP "should be flashing. The"
3700 DISP "display should read:"
3705 DISP
3710 DISP "          20 000 000"
3715 ENTER A ; M
3720 ! CHECK MEASUREMENT
3725 IF M<>20000000 THEN 3730 ELSE 3750
3730 DISP
3735 DISP "RETURNED HP-IB DATA INCORRECT"
3740 DISP
3745 DISP "          ";M;"Hz"
3750 DISP
3755 DISP B$
3760 PAUSE
3765 CLEAR
3770 DISP "          'SMOOTH'"
3775 DISP "After pressing CONT to"
3780 DISP "program the counter, verify"
3785 DISP "that the SMOOTH, REM,LSN,"
3790 DISP "and 1 megohm annunciators"
3795 DISP "are on. The GATE annunciator"
3800 DISP "should be flashing. The"
3805 DISP "display should initially show"
3810 DISP
3815 DISP "          10 000"
3820 DISP
3825 DISP "and increase the resolution"
3830 DISP "to 1 Hz."
3835 DISP
3840 PAUSE
3845 OUTPUT A ;"SMOOTH,ON;HIGHZ;SCALE,OFF"
3850 DISP
3855 DISP "Press CONT to record results"
3860 PAUSE
3865 OUTPUT A ;"SMOOTH,OFF"
3870 GOTO 6170 ! RECORD RESULTS
3875 !
3880 ! CHECKPOINT 12
3885 T=12
3890 I$="          AUTO & MANUAL"
3895 GOSUB 6085 ! DISPLAY TITLE
3900 DISP
3905 DISP "Checkpoint 12 tests the 'AUTO'"
3910 DISP "and 'MANUAL' HP-IB commands."
3915 DISP "Input a 1 GHz signal at"
3920 DISP "-5 dBm to Input 1 of the ";NS
3925 DISP
3930 DISP B$
3935 PAUSE
3940 REMOTE A
3945 ! SET UP AUTO MODE FOR
3950 ! SINGLE MEASUREMENT
3955 OUTPUT A ;"INIT"
3960 OUTPUT A ;"SAMPLE,HOLD;TRIGGER"
3965 ENTER A ; M
3970 IF M=1.E38 THEN GOTO 4205
3975 CLEAR
3980 DISP USING "3/," 'AUTO'"
3985 DISP "          'AUTO'"
3990 DISP
3995 DISP "Verify that the HOLD, REM,"
4000 DISP "TLK, FM NORM and AUTO"
4005 DISP "annunciators are on and the"
4010 DISP "NS;" is displaying"
4015 DISP
4020 DISP "          ";M;" Hz"
4025 DISP
4030 DISP "If the ";NS;" display does not"
4035 DISP "match the above reading, then"
4040 DISP "an error occurred in the HP-IB"
4045 DISP "transfer."
4050 DISP
4055 DISP B$
4060 PAUSE
4065 CLEAR
4070 DISP "          'MANUAL'"
4075 DISP
4080 DISP "Press CONT to trigger the ";NS[1,7];"."
4085 PAUSE
4090 OUTPUT A ;"MANUAL,LASTF"
4095 OUTPUT A ;"SAMPLE,HOLD;TRIGGER"
4100 ENTER A ; M1
4105 ! CHECK FOR NO ACQUISITION
4110 IF M1=1.E38 THEN GOTO 4205
4115 CLEAR
4120 DISP USING "3/," 'MANUAL'"
4125 DISP "          'MANUAL'"
4130 DISP
4135 DISP "Verify that the HOLD, REM, TLK,"
4140 DISP "and MAN annunciators are on"
4145 DISP "and the ";NS;" is displaying"
4150 DISP
4155 DISP "          ";M1;" Hz"
4160 DISP
4165 DISP "If the ";NS;" display does not"
4170 DISP "match the above reading, then"
4175 DISP "an error occurred in the HP-IB"
4180 DISP "transfer."
4185 DISP
4190 DISP "Press CONT to record the results."
4195 PAUSE
4200 GOTO 4240 ! SKIP FAIL MESSG
4205 DISP
4210 DISP "NS;" failed to acquire a"
4215 DISP "signal."
4220 DISP
4225 DISP B$
4230 DISP
4235 PAUSE
4240 GOTO 6170 ! RECORD RESULTS
4245 !
4250 ! CHECKPOINT 13
4255 T=13
4260 I$="          'FMRATE'"
4265 OUTPUT A ;"INIT"
4270 GOSUB 6085 ! DISPLAY TITLE
4275 REMOTE A
4280 DISP
4285 DISP "Checkpoint 13 tests the 'FMRATE'"

```



Table 4-1. HP-85 Program Listing (Continued)

```

4290 DISP "HP-IB command."
4295 DISP
4300 DISP "Input a 1 GHz signal at"
4305 DISP "-5 dBm to Input 1 of the ";N$
4310 DISP
4315 DISP B$
4320 PAUSE
4325 OUTPUT A ;"AUTO:FMRATE,NORMAL"
4330 CLEAR
4335 DISP "          'FMRATE',NORMAL"
4340 DISP
4345 DISP "Verify that the REM,LSN,"
4350 DISP "FM NORM, and AUTO annunciators"
4355 DISP "are on. The GATE annunciator"
4360 DISP "should be flashing."
4365 DISP
4370 DISP B$
4375 PAUSE
4380 OUTPUT A ;"FMRATE.LOW"
4385 CLEAR
4390 DISP "          'FMRATE'.LOW"
4395 DISP
4400 DISP "Verify that the REM,LSN,"
4405 DISP "FM LOW and AUTO annunciators"
4410 DISP "are on. The GATE annunciator"
4415 DISP "should be flashing."
4420 DISP
4425 DISP "Press CONT to record results"
4430 PAUSE
4435 GOTO 6170 ! RECORD RESULTS
4440 !
4445 ! CHECKPOINT 14
4450 T=14
4455 I$="          'SRQMASK'"
4460 OUTPUT A ;"INIT"
4465 GOSUB 6085 ! DISPLAY TITLE
4470 REMOTE A
4475 DISP
4480 DISP "Checkpoint 14 tests the"
4485 DISP "'SRQMASK' HP-IB command."
4490 DISP
4495 DISP B$
4500 PAUSE
4505 CLEAR
4510 DISP "          OVERLOAD bit"
4515 DISP
4520 DISP "This section tests the"
4525 DISP "overload bit of the status byte"
4530 DISP "of the ";N$
4535 DISP
4540 DISP "Press CONT to set up the mask."
4545 DISP
4550 PAUSE
4555 OUTPUT A ;"SRQMASK,8"
4560 CLEAR
4565 DISP "Set the signal source to output"
4570 DISP "a 1 GHz signal at a level of"
4575 DISP "+10 dBm. This will create the"
4580 DISP "overload condition."
4585 DISP
4590 DISP B$
4595 PAUSE
4600 ON INTR 7 GOTO 4635
4605 ENABLE INTR 7;8
4610 WAIT 3000
4615 OFF INTR 7
4620 DISP N$;" FAILED the OVERLOAD"
4625 DISP "bit test."
4630 GOTO 4665
4635 OFF INTR 7
4640 STATUS 7,1 ; B
4645 S=SPOLL(A)
4650 IF BIT(S,3) THEN 4655 ELSE 4620
4655 DISP N$;" PASSED the OVERLOAD"
4660 DISP "bit test."
4665 DISP
4670 DISP "Set the signal source output"
4675 DISP "level to -5 dBm."
4680 DISP
4685 BEEP 250,25
4690 WAIT .1
4695 BEEP 250,25
4700 DISP B$
4705 PAUSE
4710 CLEAR
4715 DISP " MEASUREMENT COMPLETED bit"
4720 DISP
4725 DISP "This section tests the"
4730 DISP "measurement completed bit of"
4735 DISP "the status byte of the ";N$
4740 DISP
4745 DISP "Press CONT to set up the mask"
4750 DISP "and test the bit."
4755 DISP
4760 PAUSE
4765 OUTPUT A ;"SAMPLE.HOLD;SRQMASK,2"
4770 ON INTR 7 GOTO 4815
4775 ENABLE INTR 7;8
4780 OUTPUT A ;"TRIGGER"
4785 WAIT 2000
4790 OFF INTR 7
4795 DISP N$;" FAILED the MEASUREMENT"
4800 DISP "COMPLETED bit test."
4805 GOTO 4840
4810 OFF INTR 7
4815 STATUS 7,1 ; B
4820 S=SPOLL(A)
4825 IF BIT(S,1) THEN 4830 ELSE 4795
4830 DISP N$;" PASSED the MEASUREMENT"
4835 DISP "COMPLETED bit test."
4840 DISP
4845 DISP B$
4850 PAUSE
4855 CLEAR
4860 DISP "          LOCAL bit"
4865 DISP
4870 DISP "This section tests the local"
4875 DISP "bit of the status byte of the"
4880 DISP N$;". "
4885 DISP
4890 DISP "Press CONT to set up the mask."
4895 DISP "and test the bit."
4900 DISP
4905 PAUSE
4910 OUTPUT A ;"SRQMASK,16"
4915 ON INTR 7 GOTO 4955
4920 ENABLE INTR 7;8
4925 LOCAL A ! SHOULD SET LCL BIT
4930 WAIT 1000
4935 OFF INTR 7
4940 DISP N$;" FAILED the LOCAL bit"
4945 DISP "test."
4950 GOTO 4985
4955 OFF INTR 7
4960 STATUS 7,1 ; B ! CLEAR 85 REG
4965 S=SPOLL(A)
4970 IF BIT(S,4) THEN 4975 ELSE 4940
4975 DISP N$;" PASSED the LOCAL bit"
4980 DISP "test."
4985 DISP
4990 DISP B$
4995 PAUSE
5000 CLEAR
5005 CLEAR

```



Table 4-1. HP-85 Program Listing (Continued)

```

5010 DISP "          ERROR bit"
5015 DISP
5020 DISP "This section tests the ERROR"
5025 DISP "bit of the status byte of the"
5030 DISP N$;". "
5035 DISP
5040 DISP "Press CONT to set up and test"
5045 DISP "this bit."
5050 PAUSE
5055 REMOTE A
5060 OUTPUT A ;"SRQMASK,4"
5065 ON INTR 7 GOTO 5120
5070 ENABLE INTR 7;8
5075 ! MANUAL FREQUENCY 9E+99 IS
5080 ! OUT OF RANGE
5085 OUTPUT A ;"MANUAL,9E+99"
5090 WAIT 1000
5095 OFF INTR 7
5100 DISP
5105 DISP N$;" FAILED the ERROR bit"
5110 DISP "test."
5115 GOTO 5155
5120 OFF INTR 7
5125 STATUS 7,1 ; B ! CLEAR 85 REG
5130 S=SPOLL(A)
5135 IF BIT(S,2) THEN 5145 ELSE 5105
5140 DISP
5145 DISP N$;" PASSED the ERROR bit"
5150 DISP "test."
5155 OUTPUT A ;"RESET"
5160 DISP
5165 DISP B$
5170 PAUSE
5175 CLEAR
5180 DISP "          OUTPUT DATA READY bit"
5185 DISP
5190 DISP "This section tests the OUTPUT"
5195 DISP "DATA READY bit of the status"
5200 DISP "byte of the ";N$;" ."
5205 DISP
5210 DISP "Press CONT to set up and test"
5215 DISP "this bit."
5220 PAUSE
5225 OUTPUT A ;"SRQMASK,1"
5230 ON INTR 7 GOTO 5275
5235 ENABLE INTR 7;8
5240 OUTPUT A ;"ID?"
5245 WAIT 1000
5250 OFF INTR 7
5255 DISP
5260 DISP N$;" FAILED the OUTPUT"
5265 DISP "DATA READY bit test."
5270 GOTO 5310
5275 OFF INTR 7
5280 ENTER A ; M$ ! Must read data
5285 STATUS 7,1 ; B ! CLEAR 85 REG
5290 S=SPOLL(A)
5295 IF BIT(S,0) THEN 5300 ELSE 5260
5300 DISP N$;" PASSED the OUTPUT"
5305 DISP "DATA READY bit test."
5310 DISP
5315 DISP "Press CONT to record results"
5320 PAUSE
5325 OUTPUT A ;"SRQMASK,4"
5330 GOTO 6170 ! RECORD RESULTS
5335 !
5340 ! CHECKPOINT 15
5345 T=15
5350 I$="          'DUMP'"
5355 OUTPUT A ;"INIT"
5360 GOSUB 6085 ! DISPLAY TITLE
5365 REMOTE A
5370 DISP
5375 DISP "Checkpoint 15 tests the"
5380 DISP "'DUMP' HP-IB command."
5385 DISP
5390 DISP "Input a 1 GHz signal at"
5395 DISP "-5 dBm to Input 1 of the"
5400 DISP N$;". "
5405 DISP
5410 DISP B$
5415 PAUSE
5420 CLEAR
5425 DISP "Press CONT to begin DUMPING"
5430 DISP "data from the ";N$;" to the"
5435 DISP "HP85. 10 measurements will be"
5440 DISP "taken and displayed."
5445 PAUSE
5450 CLEAR
5455 REMOTE A
5460 ENTER A ; M
5465 IF M=1.E38 THEN GOTO 5390
5470 OUTPUT A ;"MANUAL,LAST;RESOL,4;DUMP,ON"
5475 DISP "MEAS#          DATA FORMAT"
5480 DISP "          (GMMMCK)"
5485 FOR I=1 TO 10
5490 ENTER A USING "%,%K" : D$
5495 DISP I.D$
5500 NEXT I
5505 DISP
5510 DISP "Press CONT to record results"
5515 PAUSE
5520 OUTPUT A ;"DUMP,OFF"
5525 GOTO 6170 ! RECORD RESULTS
5530 !
5535 ! CHECKPOINT 16
5540 T=16
5545 I$="          CHECK ALL ADDRESSES"
5550 REMOTE A
5555 OUTPUT A ;"INIT"
5560 GOSUB 6085 ! DISPLAY TITLE
5565 DISP
5570 DISP "Checkpoint 16 tests all"
5575 DISP "of the valid HP-IB addresses"
5580 DISP "except 21 which is the"
5585 DISP "address of the controller."
5590 DISP
5595 DISP B$
5600 PAUSE
5605 CLEAR
5610 K=0 ! Reset failure ctr
5615 J=0 ! Reset pass ctr
5620 FOR A=700 TO 730
5625 IF A=721 THEN 5920
5630 I=A-700
5635 CLEAR
5640 LOCAL 7
5645 DISP "Press 'SET', 'HP-IB ADDRESS',"
5650 DISP I;". 'ENTER'."
5655 DISP
5660 ON KEY# 1,"INCR" GOTO 5905
5665 ON KEY# 2,"EXIT" GOTO 5925
5670 ON KEY# 3,"TEST" GOTO 5725
5675 DISP "Press EXIT to terminate this"
5680 DISP "checkpoint."
5685 DISP
5690 DISP "Press INCR to skip to the next"
5695 DISP "HP-IB address."
5700 DISP
5705 DISP "Press TEST to test the current"
5710 DISP "HP-IB address."
5715 KEY LABEL
5720 GOTO 5720
5725 CLEAR

```



Table 4-1. HP-85 Program Listing (Continued)

```

5730 OFF KEY# 1
5735 OFF KEY# 2
5740 OFF KEY# 3
5745 SET TIMEOUT 7:1000
5750 ON TIMEOUT 7 GOTO 5825
5755 REMOTE A
5760 OUTPUT A : "ID?"
5765 ENTER A ; D$
5770 IF D$<>N$ THEN GOTO 5825
5775 SET TIMEOUT 7:0
5780 K=K+1 ! Increment failure ctr
5785 D1(K)=A ! Store failed addr$
5790 DISP
5795 DISP N$;" responds at address ":A
5800 DISP
5805 DISP "Press NEXT to continue"
5810 ON KEY# 4."NEXT" GOTO 5905
5815 KEY LABEL
5820 GOTO 5820
5825 SET TIMEOUT 7:0
5830 ABORTIO 7
5835 CLEAR A
5840 DISP
5845 DISP N$;" does not respond at"
5850 DISP "address ":A
5855 BEEP 250.25
5860 WAIT .1
5865 BEEP 250.25
5870 DISP
5875 DISP "Press NEXT to continue."
5880 ON KEY# 4."NEXT" GOTO 5895
5885 KEY LABEL
5890 GOTO 5890
5895 J=J+1 ! Increment pass ctr
5900 D(J)=A ! Store pass addr$
5905 ABORTIO 7
5910 CLEAR A
5915 OFF KEY# 4
5920 NEXT A
5925 ABORTIO 7
5930 CLEAR A
5935 IF J=0 THEN 5980
5940 CLEAR
5945 DISP "The ":N$;" failed to"
5950 DISP "respond at the following"
5955 DISP "addresses:"
5960 FOR I=1 TO J
5965 DISP " " ":D(I)
5970 NEXT I
5975 GOTO 6035
5980 CLEAR
5985 IF K=0 THEN GOTO 6025
5990 DISP
5995 DISP N$;" responds at addresses:"
6000 DISP
6005 FOR I=1 TO K
6010 DISP " " ":D1(I)
6015 NEXT I
6020 GOTO 6035
6025 DISP
6030 DISP "No addresses were tested."
6035 DISP
6040 DISP B$
6045 SET TIMEOUT 7:0
6050 PAUSE
6055 OFF KEY# 1
6060 OFF KEY# 2
6065 OFF KEY# 3
6070 OFF KEY# 4
6075 GOTO 790 ! DET ADDRESS
6080 GOTO 6165 ! RECORD RESULTS
6085 !
6090 !
6095 ! DISPLAY CHECKPOINT TITLE
6100 CLEAR
6105 DISP USING "5/,"
6110 DISP H$
6115 DISP
6120 DISP " CHECKPOINT";T
6125 DISP I$
6130 DISP
6135 DISP H$
6140 DISP USING "3/,"
6145 DISP A$
6150 PAUSE
6155 CLEAR
6160 RETURN
6165 !
6170 ! RECORD TEST RESULTS
6175 CLEAR
6180 DISP USING "3/,"
6185 DISP " Press the appropriate softkey"
6190 DISP " to record the result of"
6195 DISP
6200 DISP " CHECKPOINT";T
6205 ON KEY# 1."PASS" GOTO 6225
6210 ON KEY# 4."FAIL" GOTO 6235
6215 KEY LABEL
6220 GOTO 6220
6225 R(T)=1 ! 1=PASS
6230 GOTO 6240
6235 R(T)=0 ! 0=FAIL
6240 CLEAR
6245 ! DETERMINE NEXT CHECKPOINT
6250 ! TO BE EXECUTED
6255 CLEAR
6260 DISP "Press the appropriate soft key"
6265 DISP "to select the desired checkpoint..."
6270 DISP
6275 DISP
6280 DISP "NEXT- Press K1 to perform the"
6285 DISP "next checkpoint."
6290 DISP "EXIT-Press K2 to end the"
6295 DISP "program."
6300 DISP "REPEAT- Press K3 to repeat this"
6305 DISP "checkpoint."
6310 DISP "GOTO#- Press K4 to select an"
6315 DISP "arbitrary checkpoint."
6320 ON KEY# 1."NEXT" GOTO 6350
6325 ON KEY# 2." EXIT" GOTO 6360
6330 ON KEY# 3." REPEAT" GOTO 6370
6335 ON KEY# 4." GOTO#" GOTO 6380
6340 KEY LABEL
6345 GOTO 6345
6350 D=T+1
6355 GOTO 6405
6360 D=0
6365 GOTO 6405
6370 D=T
6375 GOTO 6405
6380 CLEAR
6385 DISP "Enter checkpoint number desired"
6390 DISP "(1 to 16), and press END LINE"
6395 INPUT D
6400 IF D<1 OR D>16 THEN 6380
6405 OFF KEY# 1
6410 OFF KEY# 2
6415 OFF KEY# 3
6420 OFF KEY# 4
6425 !
6430 ! BRANCH EXECUTION TO
6435 ! DESIRED CHECKPOINT
6440 IF D=0 THEN 6635
6445 IF D>7 THEN 6455

```



Table 4-1. HP-85 Program Listing (Continued)

```
6450 ON D GOTO 1010,1275,1445,1555,1825,2295,2460
6455 D=D-7
6460 IF D=10 THEN GOTO 6635
6465 ON D GOTO 2730,3020,3225,3465,3875,4245,4440,5335,5530
6470 !
6475 ! SUBROUTINE TO DETERMINE
6480 ! FIRST CHECKPOINT EXECUTED
6485 CLEAR
6490 DISP "Press the soft key to select"
6495 DISP "the desired checkpoint..."
6500 DISP USING "2/,"
6505 DISP "FIRST- Press K1 to perform the"
6510 DISP "first checkpoint."
6515 DISP
6520 DISP "EXIT- Press K2 to end the"
6525 DISP "program."
6530 DISP
6535 DISP "GOTO#- Press K4 to select an"
6540 DISP "arbitrary checkpoint."
6545 ON KEY# 1,"FIRST" GOTO 6570
6550 ON KEY# 2,"EXIT" GOTO 6580
6555 ON KEY# 4,"GOTO#" GOTO 6590
6560 KEY LABEL
6565 GOTO 6565
6570 D=T+1
6575 GOTO 6615
6580 D=0
6585 GOTO 6615
6590 CLEAR
6595 DISP "Enter checkpoint number desired"
6600 DISP "(1 to 16), and press END LINE"
6605 INPUT D
6610 IF D<1 OR D>16 THEN 6380
6615 OFF KEY# 1
6620 OFF KEY# 2
6625 OFF KEY# 4
6630 RETURN
6635 !
6640 !          PRINTOUT CHECKPOINT
6645 !                RESULTS
6650 CLEAR
6655 DISP "Do you wish to have a"
6660 DISP "printout of the results?"
6665 ON KEY# 1,"YES" GOTO 6685
6670 ON KEY# 4,"NO" GOTO 6810
6675 KEY LABEL
6680 GOTO 6680
6685 CLEAR
6690 PRINT H$
6695 PRINT
6700 PRINT "          HP-IB VERIFICATION"
6705 PRINT "                RESULTS"
6710 PRINT
6715 PRINT H$
6720 PRINT
6725 PRINT "CHECKPOINT          RESULTS"
6730 CLEAR
6735 FOR T=1 TO 9
6740 IF R(T)=1 THEN R$="    PASS"
6745 IF R(T)=0 THEN R$="    FAIL"
6750 IF R(T)=2 THEN R$="NOT PERFORMED"
6755 PRINT "    :T:"          ":R$"
6760 NEXT T
6765 FOR T=10 TO 16
6770 IF R(T)=1 THEN R$="    PASS"
6775 IF R(T)=0 THEN R$="    FAIL"
6780 IF R(T)=2 THEN R$="NOT PERFORMED"
6785 PRINT "    :T:"          ":R$"
6790 NEXT T
6795 FOR I=1 TO 5
6800 PRINT
6805 NEXT I
6810 OUTPUT A ;"INIT"
6815 CLEAR
6820 OFF KEY# 1
6825 OFF KEY# 4
6830 LOCAL 7
6835 DISP USING "5/,"
6840 DISP "          HP-IB VERIFICATION COMPLETED"
6845 END
```



Table 4-2. Sample HP-IB Verification Printout

```
*****
*****
CHECKPOINT SUMMARY
*****

1 Remote/Local Lockout, Local
2 Self Check ('TEST?')
3 'DISPLAY'
4 'INIT' & 'RESET'
5 'REF' & 'OVEN'
6 'ERR?'
7 'SET' & 'SET?'
8 'LOWZ' & 'HIGHZ'
9 'SAMPLE' & 'TRIGGER'
10 'RESOL' & 'HIRESOL'
11 'OFFSET', 'SCALE' & 'SMOOTH'
12 'AUTO' & 'MANUAL'
13 'FMRATE'
14 'SRQMASK'
15 'DUMP'
16 CHECK ALL ADDRESSES
```

```
*****
HP-IB VERIFICATION
RESULTS
*****
```

```
*****
CHECKPOINT          RESULTS
1                   PASS
2                   FAIL
3                   PASS
4                   PASS
5                   FAIL
6                   PASS
7                   NOT PERFORMED
8                   PASS
9                   PASS
10                  PASS
11                  FAIL
12                  PASS
13                  PASS
14                  PASS
15                  PASS
16                  NOT PERFORMED
```

Table 4-3. Operation Verification Record

Hewlett-Packard Model 5350A/5351A/5352A Microwave Frequency Counter		Tested by _____	
Serial No. _____		Date _____	
PARA. NO.	TEST	RESULTS	SPECIFICATION
4-18	Power-Up Self Test	Pass ____ Fail ____	
4-19	INPUT 2 Gating and Counting Check	Pass ____ Fail ____	
4-20	INPUT 2, 10 Hz-525 MHz Input Sensitivity Test (50Ω/1MΩ):	(record actual sensitivity)	
	50Ω: 50 MHz	_____	25 mV rms (-19.3 dBm)
	100 MHz	_____	
	250 MHz	_____	
	525 MHz	_____	
	1MΩ: 80 MHz	_____	
	1MΩ: 10 Hz	_____	
	50 kHz	_____	
	1 MHz	_____	
	10 MHz	_____	
	20 MHz	_____	
4-22	INPUT 1, 500 MHz-20 GHz [26.5 GHz, 40 GHz] Input Sensitivity Test:		
	500 MHz	_____	-25 dBm
	1 GHz	_____	
	5 GHz	_____	
	12.4 GHz	_____	
	18 GHz	_____	-20 dBm [-25 dBm, 5352A]
	20 GHz	_____	
	[5351A, 5352A] 22 GHz	_____	-15 dBm [-25 dBm, 5352A]
	26.5 GHz	_____	
	[5352A] 30 GHz	_____	0.741f(GHz) - 44.6 dBm
	34 GHz	_____	
	40 GHz	_____	-15 dBm
4-24	HP-IB Verification	Pass ____ Fail ____	

4-30. PERFORMANCE TEST PROCEDURE

4-31. INPUT 2, 10 Hz-525 MHz Input Sensitivity Test

4-32. The following test is in two parts, Setup 1 for 10 MHz to 525 MHz, and Setup 2 for 10 Hz to 10 MHz.

Specification: 50 Ω : 10 MHz-525 MHz, 25 mV rms
1M Ω : 10 Hz-80 MHz, 25 mV rms

Description: The counter is set to the 10 MHz-525 MHz range, 50 Ω impedance, and a -19.3 dBm signal is applied to INPUT 2. The test generator is set to selected frequencies and the 5350A/51A/52A is checked for proper counting. The counter is next set for 1M Ω impedance, a -19.3 dBm signal is applied to INPUT 2 through a 50 Ω feedthrough, and the counter is checked for proper counting at 50 MHz and 80 MHz. The test setup is changed to Setup 2 to test the 10 Hz-10 MHz range.

Setup 1: INPUT 2, 50 MHz-525 MHz

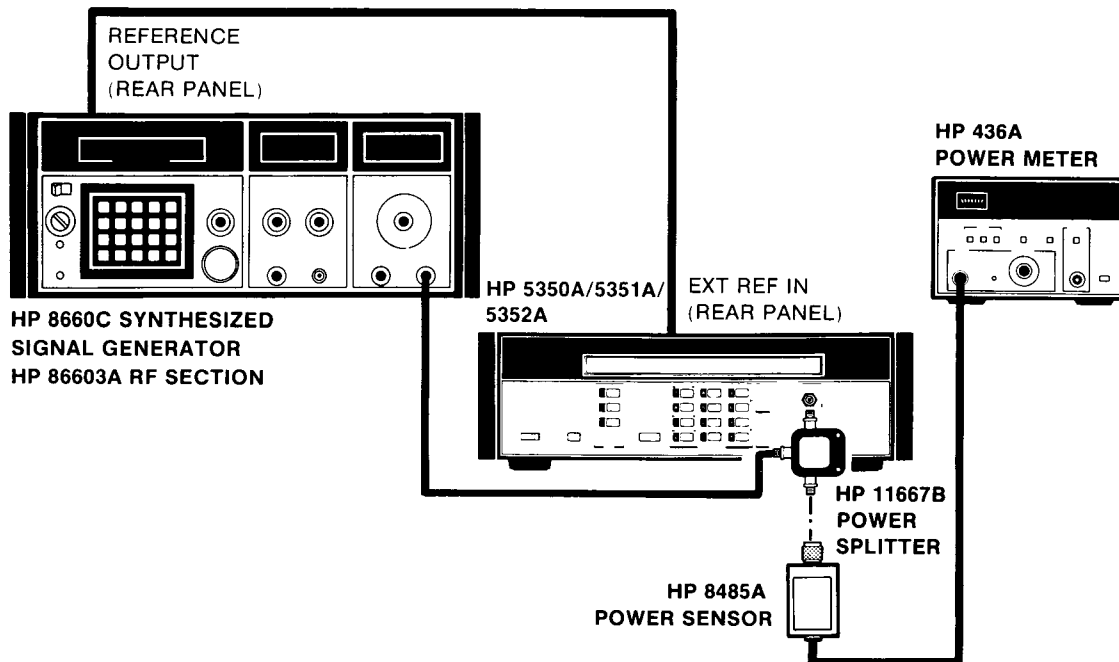

- Set the counter to the 10 MHz-525 MHz range, 50 Ω impedance, by pressing the 50 Ω key.
- Set the 8660C to 50 MHz, and the 86603A for an output level of 25 mV rms (-19.3 dBm) as measured on the 436A Power Meter. Verify that the counter counts 50 MHz, 100 MHz, 400 MHz, and 525 MHz, ± 1 Hz. Record the actual sensitivity at each frequency in the Performance Test Record (Table 4-4).
- Connect the 11667B to INPUT 2 of the counter via a 50 Ω feedthrough. Press the 1M Ω key on the 5350A/51A/52A.
- Verify that the 5350A/51A/52A counts 50 MHz and 80 MHz, ± 1 Hz, at 25 mV rms (-19.3 dBm). Enter the results in the Performance Test Record.

Setup 2: INPUT 2, 10 Hz-10 MHz

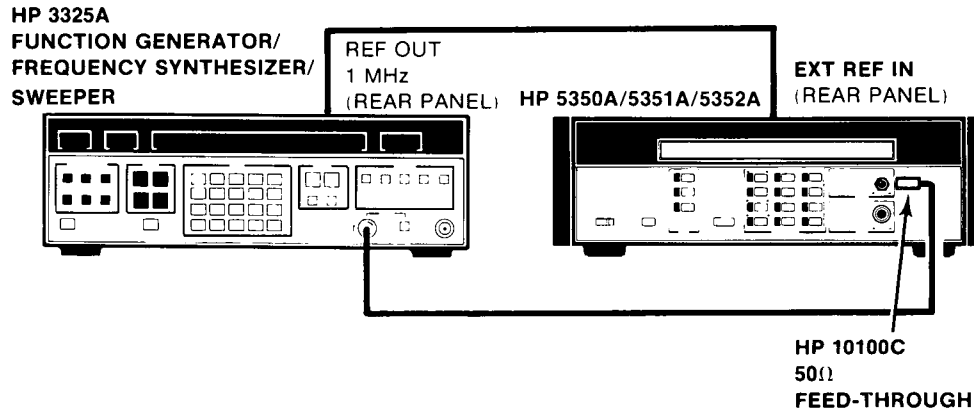

- a. 5350A/51A/52A settings are the same as in the 50/80 MHz test (INPUT 2, 1M Ω).
 - b. Connect the 3325A to INPUT 2 of the counter via a 50 Ω feedthrough. Set the 3325A for an output of 25 mV rms (-19.3 dBm) at 10 Hz.
 - c. Verify that the counter counts properly at 10 Hz, 1 kHz, 500 kHz, 1 MHz, and 10 MHz, \pm 1 Hz. Record the actual sensitivity in the Performance Test Record.
- 4-33. If the counter fails any of the above sensitivity tests, refer to Section V, Adjustments, and verify the INPUT 2 sensitivity adjustment (Peak Detector Adjustment, A2R1). If this adjustment is correct, and the counter continues to fail the sensitivity tests, refer to Section VIII, Service, for troubleshooting procedures for the following assemblies, in the order shown:

A2 Low Frequency Input Assembly

A3 Counter Assembly

4-34. INPUT 1, 500 MHz-20 GHz [26.5 GHz, 40 GHz] Input Sensitivity Test

4-35. The following test is in three parts, Setup 1 for 500 MHz to 1 GHz, Setup 2 for 2.5 GHz to 20 GHz [26.5 GHz], and Setup 3 for 26.5 GHz to 40 GHz.

Specifications:	5350A sensitivity	= -25 dBm, 500 MHz-12.4 GHz
		= -20 dBm, 12.4 GHz-20 GHz
	5351A sensitivity	= -25 dBm, 500 MHz-12.4 GHz
		= -20 dBm, 12.4 GHz-20 GHz
		= -15 dBm, 20 GHz-26.5 GHz
	5352A sensitivity	= -25 dBm, 500 MHz-26.5 GHz
		= $0.741 \times \text{freq. in GHz} - 44.6 \text{ dBm}$, for frequencies greater than 26.5 GHz.
		(-15 dBm at 40 GHz)

Description: The counter is set to the 500 MHz-20 GHz [26.5 GHz, 40 GHz] range and the appropriate input signal is applied to INPUT 1. The generator is set to selected frequencies up to 1 GHz, and the actual sensitivity of the 5350A/51A/52A is measured. The test setup is changed to Setup 2 to measure sensitivity in the 2.5 GHz-20 GHz [26.5 GHz] range. If a 5351A or 5352A is being tested, the generator is set to the appropriate test level, and actual sensitivity is measured at selected frequencies up to 26.5 GHz. If a 5352A is being tested, the test setup is changed to Setup 3 to measure sensitivity in the 26.5 GHz-40 GHz range.

Setup 1: 500 MHz-1 GHz:

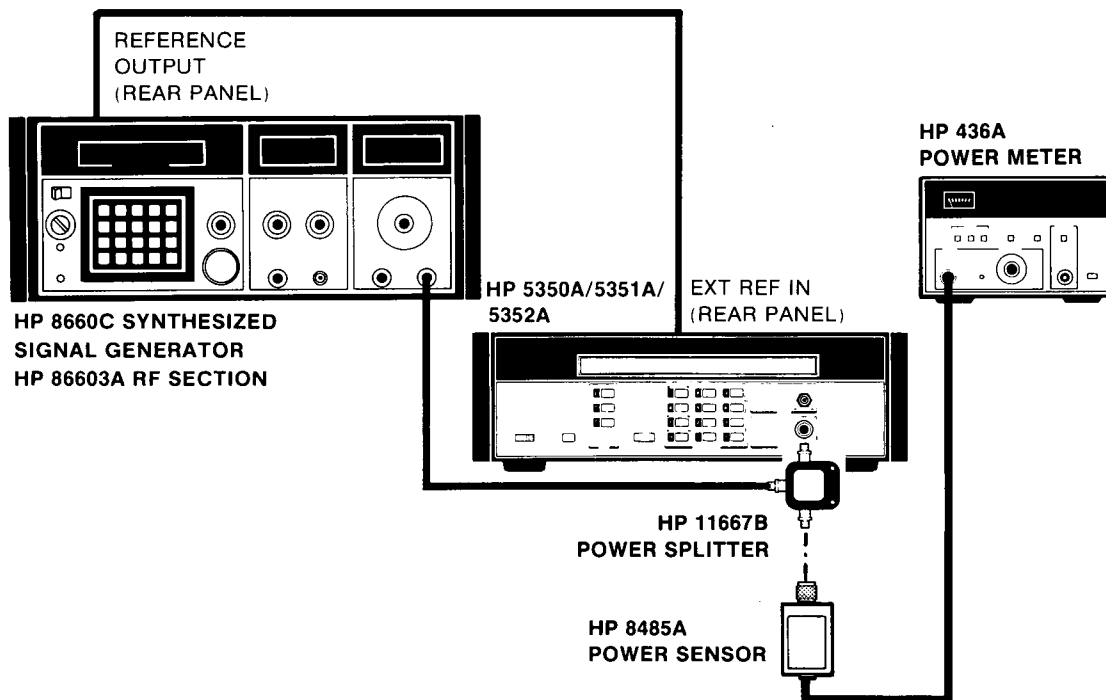

- Set the counter to INPUT 1, Automatic mode by pressing the AUTO key.
- Connect the equipment as shown in Setup 1.
- Set the 8660C to 500 MHz, and set the 86603A to -25 dBm, as measured on the 436A.

- d. Measure the actual sensitivity at 500 MHz and 1 GHz. (The counter should measure these frequencies to ± 4 Hz). Verify the signal levels with the 436A Power Meter at each frequency. Enter the result on the Performance Test Record.

Note: The ± 4 Hz tolerance is the result of the ± 1 count accuracy specification (± 1 Hz), and the residual stability specification of ± 1 LSD rms (± 3 Hz).

Setup 2: INPUT 1, 2.5 GHz-20 GHz [26.5 GHz]

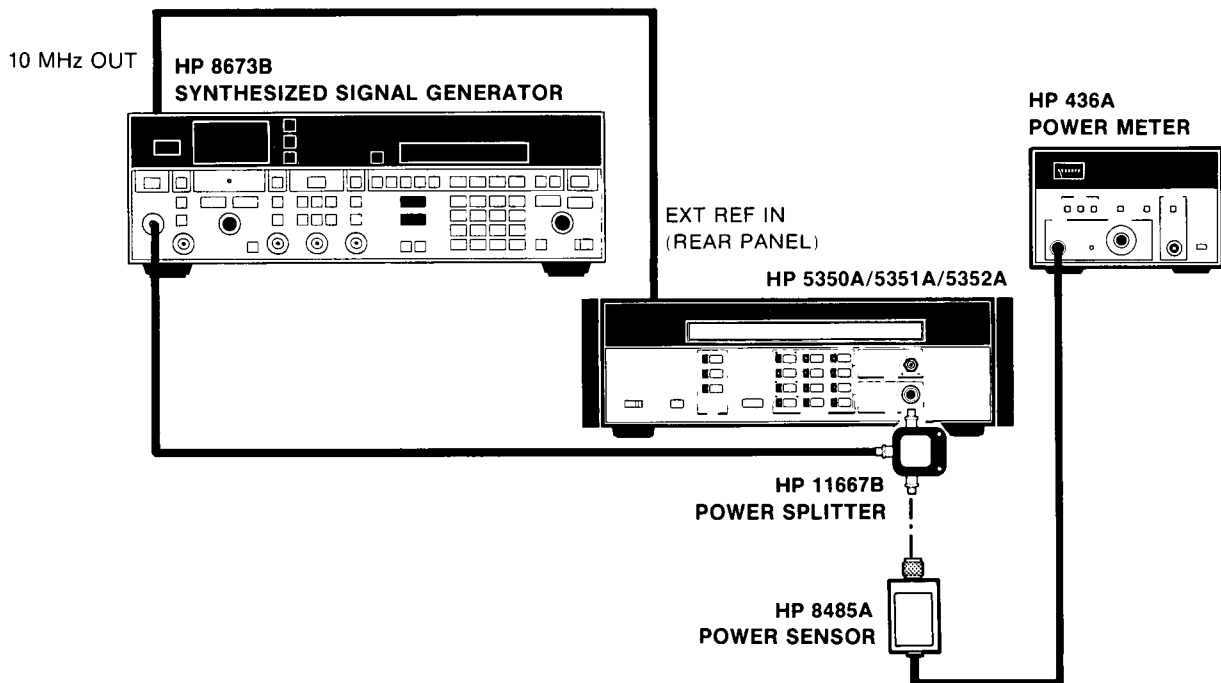

- a. 5350A/51A/52A settings are the same as in Setup 1 (INPUT 1, Auto).
- b. Connect the equipment as shown in Setup 2.
- c. Set the 8673B to 2.5 GHz at level of -25 dBm, as measured on the 436A.
- d. Measure actual sensitivity at 2.5, 5, 10, and 12.4 GHz, by first verifying the signal level with the 436A, and then verifying that each of the frequencies is counted to ± 4 Hz.
- e. Set the 8673B to 18 GHz at a level of -20 dBm [-25 dBm, 5352A], as measured on the 436A.
- f. Measure actual sensitivity at 18, 19, and 20 GHz, by first verifying the signal level with the 436A, and then verifying that each of the frequencies is counted to ± 4 Hz.
- g. If a 5351A or 5352A is being tested, repeat the above procedure for 20-26.5 GHz at the appropriate input level [-15 dBm for the 5351A, -25 dBm for the 5352A]. Measure actual sensitivity at 22 GHz, 24 GHz, and 26.5 GHz [± 4 Hz, 5351A and 5352A].
- h. Enter the results in the Performance Test Record.

Setup 3: INPUT 1, 26.5 GHz-40 GHz [5352A]

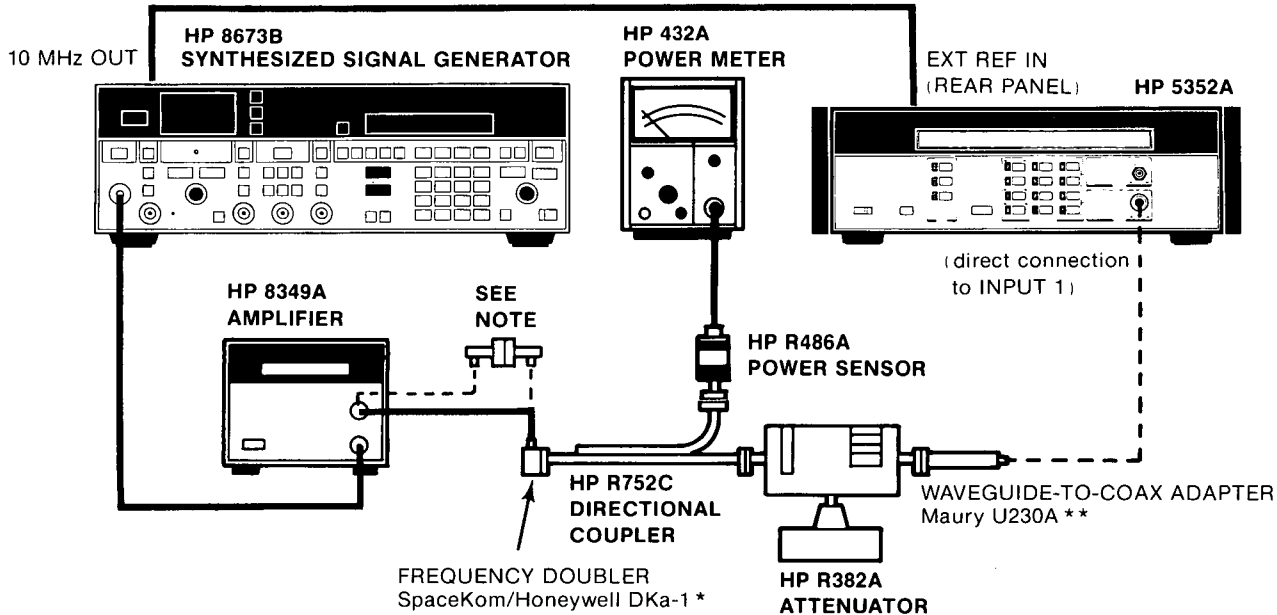

* Available from: Honeywell, Inc., Santa Barbara Microwave Division, 214 E. Gutierrez St., Santa Barbara, CA 93101.

** Available from: Maury Microwave Corporation, 8610 Helms Avenue, Cucamonga, CA 91730.

- a. 5352A settings are the same as for Setup 1 (INPUT 1, Auto).
- b. Connect the equipment as shown in Setup 3.

CAUTION

To prevent damage to the frequency doubler from excessive input levels, be sure that the 8349A Amplifier is turned off before turning on the signal source, and that the output level of the source is set to approximately -20 dBm before the 8349A Amplifier is turned on.

NOTE

When testing at 40 GHz, two waveguide-to-coax adapters (one HP K281C standard, and one HP K281C Option 012), arranged in a back-to-back configuration, must be inserted at the output of the 8349A Amplifier to prevent subharmonics of the 20 GHz signal from entering the frequency doubler.

- c. Measure the actual sensitivity at 26.5 GHz, 30 GHz, 34 GHz, and 40 GHz, as follows:
 - 1. Set the 8673B to 13.25 GHz, and set the level for a +15 dBm output from the 8349A Amplifier (as indicated on the 8349A front panel display).
 - 2. Add attenuation by adjusting the R382A Precision Attenuator until the counter stops measuring, then decrease the attenuation until the counter measures the input frequency within ± 5 Hz.

3. Note the doubled frequency (26.5 GHz) power reading on the 432A, add +10 dB to the reading, and subtract the value of the R382A attenuator setting to obtain the sensitivity level of the counter.
4. Repeat the above steps at 30 GHz, 34 GHz, and 40 GHz (15, 17, and 20 GHz input to the doubler, respectively).

d. Enter the actual sensitivity results in the Performance Test Record.

Note: The ± 5 Hz tolerance is the result of the ± 1 count accuracy specification (± 1 Hz), and the residual stability specification of ± 1.4 LSD rms (± 4.2 Hz), rounded to the nearest Hertz.

4-36. If the counter fails any of the above sensitivity tests, refer to Section V, Adjustments, and verify the A6 IF Amplifier/Detector Assembly adjustments. If these adjustments are correct, and the counter continues to fail the above tests, refer to Section VIII, Service, for troubleshooting procedures for the following assemblies:

Microwave Module (A12 Microwave Assembly/U1 Sampler)

A6 IF Amplifier/Detector Assembly

A3 Counter Assembly

A5 Synthesizer Assembly

4-37. Automatic Amplitude Discrimination Test

Specification: The 5350A/51A/52A measures the largest of all signals present, provided that the signal is 6 dB (typical) above any signal within 500 MHz; 20 dB (typical) above any signal, 500 MHz to 20 GHz [26.5 GHz, 40 GHz].

Description: Two microwave generators are used to provide two signals into the 5350A/51A/52A. The relative level of the two signals is adjusted to the specification and the 5350A/51A/52A must count the higher amplitude signal.

Setup:

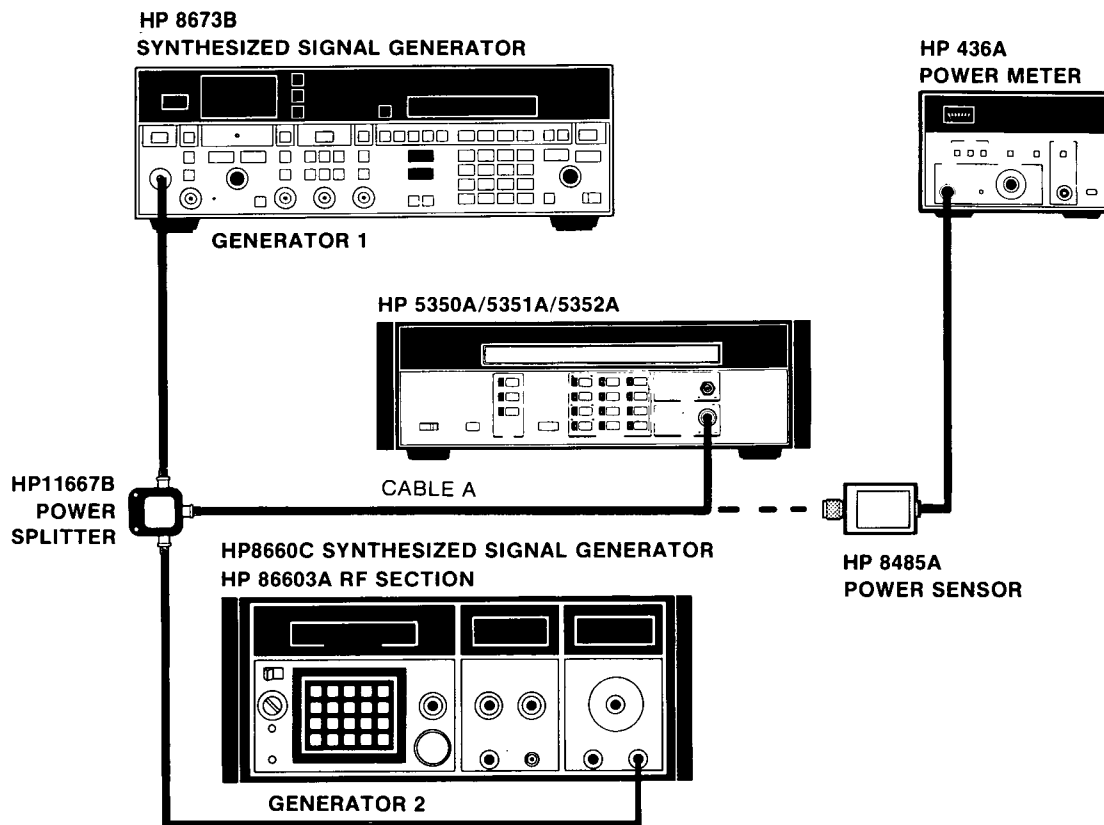

NOTE

The second frequency source is not required to have a wideband capability. The frequency range of generator 2 need only be 500 MHz to 2 GHz.

- a. Set generator 1 for an 18 GHz output at a level to deliver -5 dBm to the 5350A/51A/52A. To set this level, disconnect generator 2 from the 11667B and terminate that port of the 11667B with a 909D 50Ω termination. Connect the 8485A to the 5350A/51A/52A end of cable A and adjust the 8673B output for a -5 dBm reading.
- b. Set generator 2 for a 500 MHz output at a level to deliver -25 dBm to the 5350A/51A/52A. To set this level, disconnect generator 1 from the 11667B input (reconnect generator 2 to the 11667B) and terminate the generator 1 port of the 11667B with the 909D 50Ω termination. Connect the 8485A to the 5350A/51A/52A end of cable A and adjust the 86603A for a -25 dBm reading.
- c. Connect both generators to the 11667B inputs. Connect cable A to INPUT 1 of the counter. Verify that the 5350A/51A/52A counts 18 GHz. Increase the level of generator 2 until the 5350A/51A/52A counts incorrectly; measure that level (using the procedure described above) and enter the result on the Performance Test Record.

- d. Set generator 1 for a 2.5 GHz output at a level to deliver -5 dBm to the 5350A/51A/52A using the technique described above. Set generator 2 for a 2.0 GHz output at a level to deliver -11 dBm to the 5350A/51A/52A using the same technique. Connect both generators to the 11667B, and cable A to the 5350A/51A/52A. Verify that the 5350A/51A/52A counts 2.5 GHz. Increase the generator 2 level until the 5350A/51A/52A counts incorrectly; measure that level and enter the result on the Performance Test Record.

4-38. If the counter fails the above Automatic Amplitude Discrimination tests, refer to Section VIII, Service, for troubleshooting procedures for the following assemblies:

- A6 IF Amplifier/Detector Assembly
- Microwave Module (A12 Microwave Assembly/U1 Sampler)

4-39. FM Tolerance Test

Specification: 5350A/5351A: 20 MHz maximum peak-to-peak deviation
5352A: 12 MHz maximum peak-to-peak deviation

Description: The FM peak-to-peak deviation specification indicates the worst case FM deviation which can be present on a carrier that the counter can acquire and count. The counter averages out the deviations and displays a carrier frequency. In addition, the 5350A/51A/52A offers a choice of FM rate tolerance modes. This test will verify that the counter performs properly in both modes.

Setup:

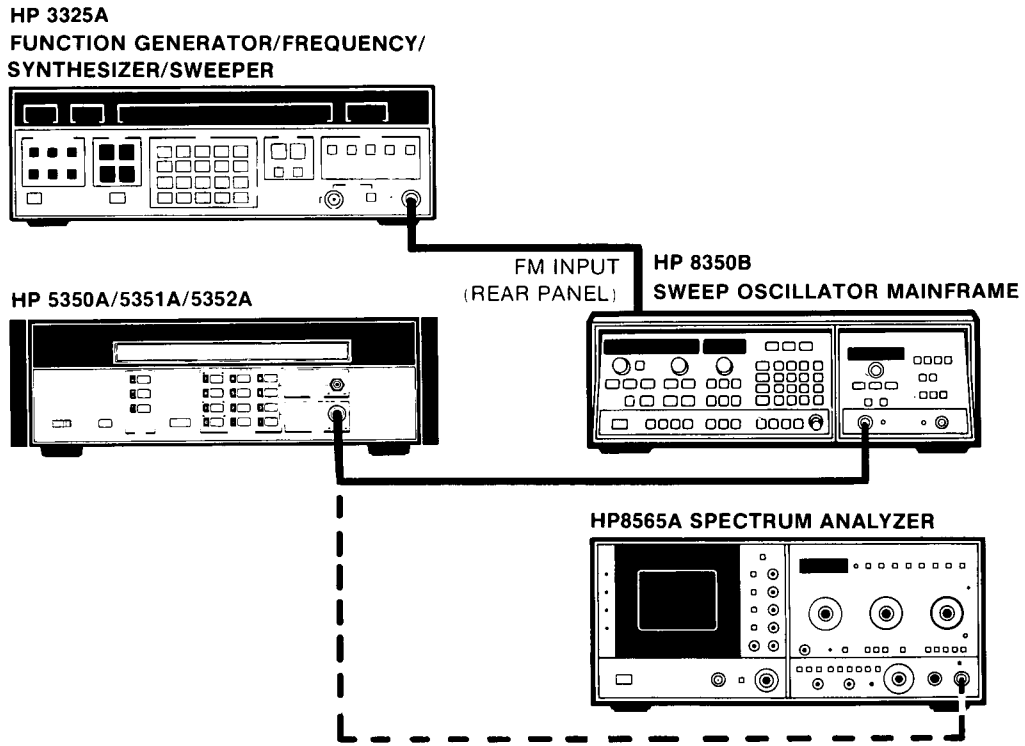

- a. Set the 8350B to 1 GHz and the 83595A to -5 dBm.
- b. Set the 3325A to 1 kHz.
- c. Using the 8565A Spectrum Analyzer to verify the width of the FM deviation at the output of the 83595A, set the amplitude of the 3325A output to achieve a peak-to-peak width of 20 MHz [12 MHz, 5352A].
- d. Set the 5350A/51A/52A to the Automatic measurement mode by pressing the AUTO key. Be sure that the counter is set for Normal FM Rate Tolerance (FM NORM annunciator lit).
- e. Verify that the counter acquires and counts the modulated input correctly. Enter the results in the Performance Test Record.
- f. Set the 5350A/51A/52A to Diagnostic 6 by pressing SET/ENTER, DIAGNOSTICS, 6, SET/ENTER. The counter will display the determined harmonic number, including the fractional portion. Verify that the fractional portion of the displayed harmonic number does not deviate more than .30 from the integer value. (For example, a harmonic number of 3 should not deviate to less than 2.70, or greater than 3.30.)
- g. Set the 3325A to 45 Hz. Set the 5350A/51A/52A for Low FM Rate Tolerance (FM LOW annunciator on) by pressing the FM RATE TOL key. Verify that the fractional portion of the displayed harmonic number still does not deviate more than .30 from the integer value. (The deviation of the fractional portion typically will be significantly narrower in the FM LOW mode than in the FM NORM mode.) Press the RESET/LOCAL key, and verify that the displayed count matches that of the Normal FM Rate mode. Enter the results in the Performance Test Record.

4-40. If the counter fails the FM Tolerance test, refer to Section V, Adjustments, and verify the A6 IF Amplifier/Detector Assembly adjustments. If the adjustments are correct and the counter continues to fail, refer to Section VIII, Service, for troubleshooting procedures for the following assemblies:

A6 IF Amplifier/Detector Assembly

Microwave Module (A12 Microwave Assembly/U1 Sampler)

4-41. HP-IB Verification Test

4-42. Perform the HP-IB Verification Test procedures at paragraph 4-24. After completion of the program, a printout should be attached to the Performance Test Record (*Table 4-4*).

Table 4-4. Performance Test Record

Hewlett-Packard Model 5350A/5351A/5352A Microwave Frequency Counter		Tested by _____	
Serial No. _____		Date _____	
PARA. NO.	TEST	ACTUAL SENSITIVITY	SPECIFICATION
4-31	INPUT 2, 10 MHz-525 MHz Input Sensitivity (50Ω):	50 MHz _____ 100 MHz _____ 200 MHz _____ 400 MHz _____ 525 MHz _____	25 mV rms (-19.3 dBm)
	INPUT 2, 10 Hz-80 MHz Input Sensitivity (1MΩ):	10 Hz _____ 1 kHz _____ 500 kHz _____ 1 MHz _____ 10 MHz _____ 50 MHz _____ 80 MHz _____	25 mV rms (-19.3 dBm)
4-34	INPUT 1, 500 MHz-20 GHz [26.5 GHz, 40 GHz] Input Sensitivity:	500 MHz _____ 1 GHz _____ 2.5 GHz _____ 5 GHz _____ 10 GHz _____ 12.4 GHz _____ 16 GHz _____ 18 GHz _____ 19 GHz _____ 20 GHz _____ [5351A/5352A] 22 GHz _____ 24 GHz _____ 26.5 GHz _____ [5352A] 30 GHz _____ 34 GHz _____ 40 GHz _____	-25 dBm -20 dBm [-25 dBm, 5352A] -15 dBm [-25 dBm, 5352A] 0.741f(GHz) - 44.6 dBm
4-37	Automatic Amplitude Discrimination:	(record actual separation) 17.5 GHz separation _____ dB 500 MHz separation _____ dB	20 dB (typical) 6 dB (typical)
4-39	FM Rate Tolerance:	Normal (1 kHz) Pass _____ Fail _____ Low Rate (45 Hz) Pass _____ Fail _____	
4-41	HP-IB Verification	Pass _____ Fail _____	